



Datasheet

Model Number : TMT4035M

DC~40GHz, 35W, 2.92mm Male Coaxial Termination

Specifications

Frequency Range	DC-40GHz
Input Avg Power	35W @25deg. C
Peak Power	200W (5μsec pulse width, 8% duty cycle)
VSWR	1.3 max.
Impedance	50 Ohms
Connector	2.92mm Male
Connector Body	Passivated stainless brass
Center Contact	Gold plated beryllium copper(≥1.27um)
Operating Temperature	-55~+100deg. C
Storage Temperature	-55~+125deg. C
Heat Sink	Black anodized aluminum
RoHS Status	RoHS Compliant

Dimensions[mm]:

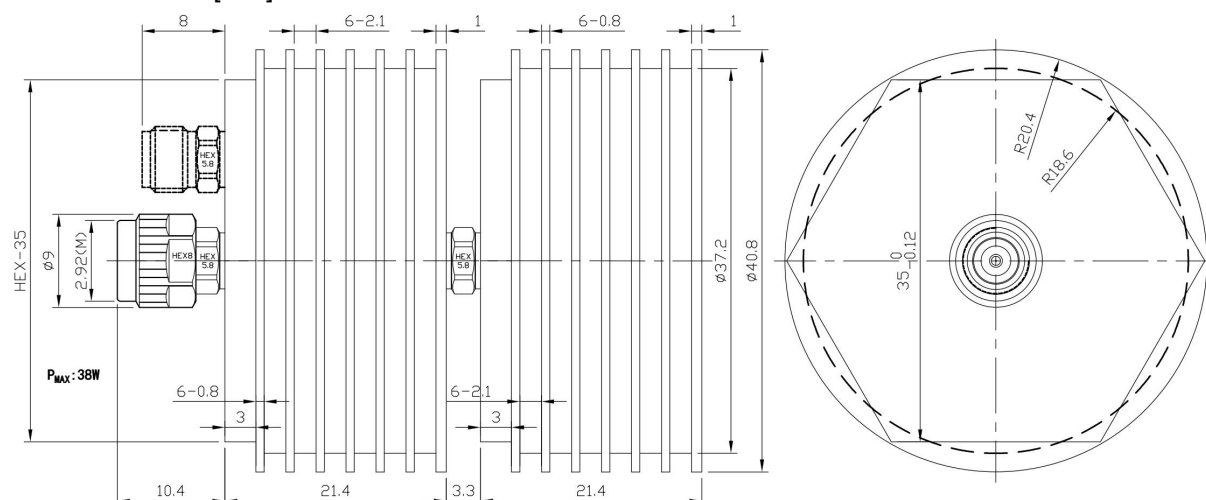

Typical Test Curve

