



## Datasheet

Model Number : TMT508F

# DC~50GHz, 8W, 2.4mm Female Coaxial Termination

## Specifications

Frequency Range	DC-50GHz
Input Avg Power	8W @25deg. C
Peak Power	100W (5μsec pulse width, 3% duty cycle)
VSWR	1.3 max.
Impedance	50 Ohms
Connector	2.4mm Female
Connector Body	Passivated stainless brass
Center Contact	Gold plated beryllium copper(≥1.27um)
Operating Temperature	-55~+100deg. C
Storage Temperature	-55~+125deg. C
Heat Sink	Black anodized aluminum
RoHS Status	RoHS Compliant

### Dimensions[mm]:

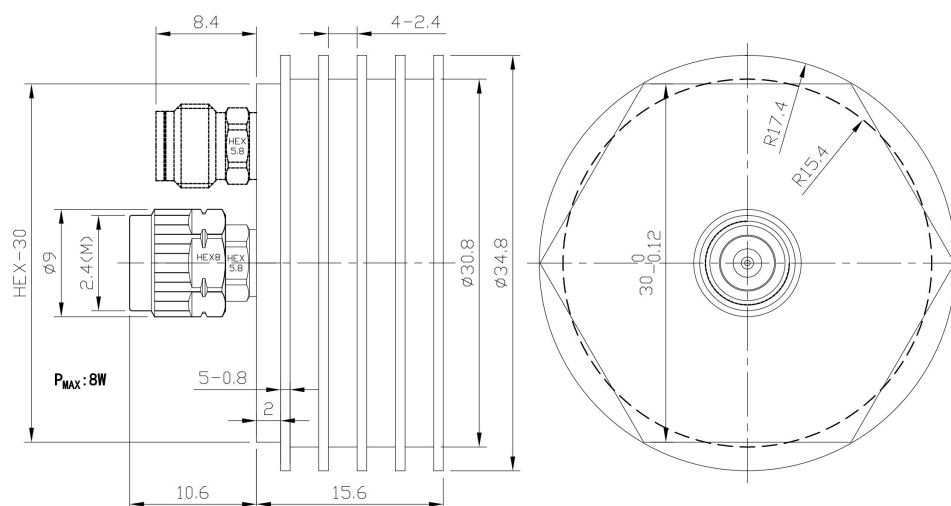

## Typical Test Curve

