

Datasheet

Model Number : TMT5035M

DC~50GHz, 35W, 2.4mm Male Coaxial Termination

Specifications

Frequency Range	DC-50GHz
Input Avg Power	35W @25deg. C
Peak Power	100W (5μsec pulse width, 10% duty cycle)
VSWR	1.38 max.
Impedance	50 Ohms
Connector	2.4mm Male
Connector Body	Passivated stainless steel
Center Contact	Gold plated beryllium copper(≥1.27um)
Operating Temperature	-55~+100deg. C
Storage Temperature	-55~+125deg. C
Heat Sink	Black anodized aluminum
RoHS Status	RoHS Compliant

Dimensions[mm]:

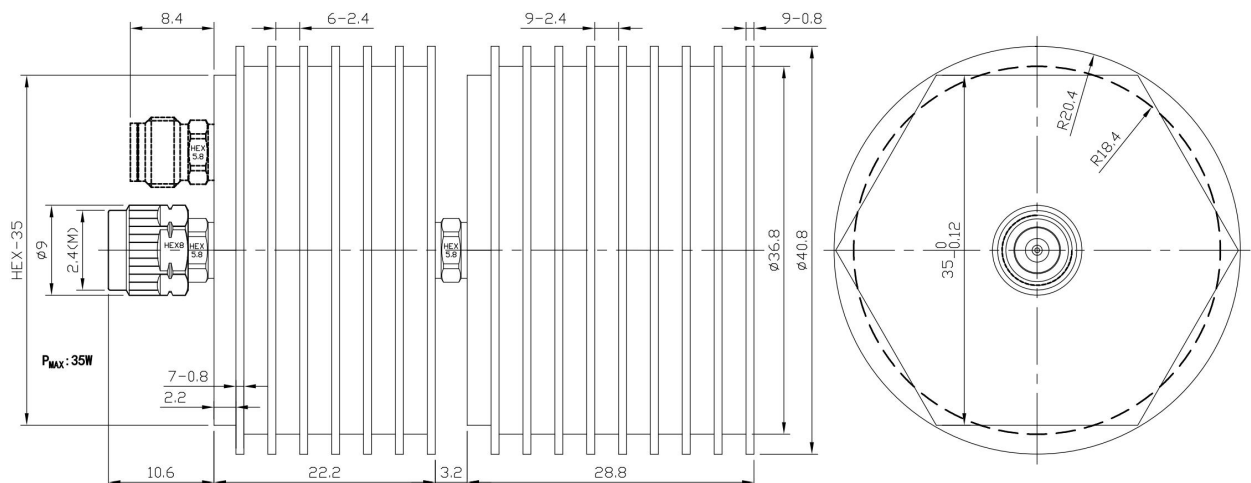

Typical Test Curve

