

FEATURES

- Small Size
- High Accuracy
- High Stability

APPLICATIONS

- Laboratory Test and Measurement
- Wireless Communication



Electrical Specifications

Frequency Range	0.2~6GHz
Impedance	50Ω nominal
Attenuation Range	0~63.5dB in 0.5dB steps
Attenuation Steps(dB)	0.5, 1, 2, 4, 8, 16, 32
Switching Time	2μs
VSWR	1.8 max
Accuracy	±(0.1+5%)dB@F≤0.8GHz ±(0.3+3%)dB@F>0.8GHz
Insertion Loss	9.5dB max
Average Power	1W
Operating Voltage	+3V~+5V
V _L (Input Low Level)	0V~+0.8V
V _H (Input High Level)	+3V~+5V
Temperature Range	-55°C~+125°C
RoHS Status	RoHS Compliant

Mechanical Specifications

RF Connector	SMA female
Connector Body	Nickel Plated Brass
Female Pin	Gold Plated Beryllium Cooper
Housing	Aluminum, Anodic Oxidation
Size	72×38×20mm

◇ Test Data is available at an additional cost ◇

Dimensions [mm]

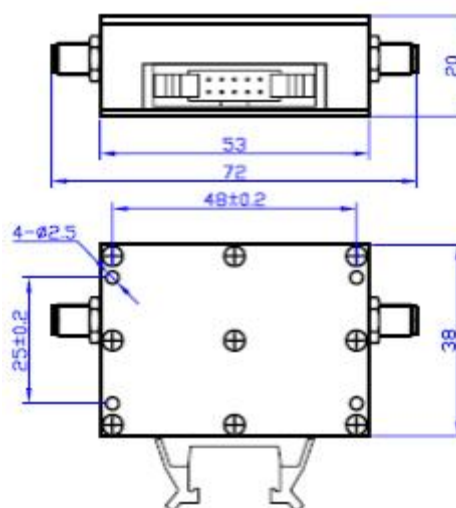

Control Connector PIN

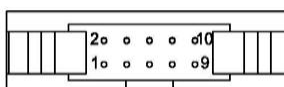

PIN No.	1	2	3	4	5	6	7	8	9	10
dB, 7 Cells	0.5	1	2	4	8	16	32	N	Vdd	GND

N: Not Connected