

TMDC-02004000-30K30 2-40 GHz, 30dB, 30W, 2.92mm Female

FEATURES

- ❖ Wide Band Operation 2-40 GHz
- ❖ Power Handle Capability up to 30W
- ❖ 30 dB Typical Coupling
- ❖ Low Insertion Loss

APPLICATIONS

- ❖ Frequency Measurements
- ❖ Signal Levelling, Signal Sampling
- ❖ Signal Injection
- ❖ Reflection Coefficient Measurements
- ❖ Measure incident and reflected power to determine VSWR

SPECIFICATIONS

Parameters	Min.	Typ.	Max.	Units
Frequency Range	2	-	40	GHz
Impedance	-	50	-	Ohms
Nominal Coupling	29	30	31.5	dB
Frequency Sensitivity	-	±0.7	±1.0	dB
Directivity	10	13	-	dB
Insertion Loss(Excluding coupling loss)	-	-	1.5	dB
Insertion Loss(True)	-	1.1	1.6	dB
VSWR Primary	-	1.4	1.5	:1
VSWR Secondary	-	1.4	1.5	:1
Average Power	30			W
Peak Power	500(10% Duty Cycle, 1μs Pulse Width)			W
Operating Temperature	-40°C~+85°C			
Storage Temperature	-50°C~+105°C			
Input/Output Connectors	2.92mm female			
Weight	35g			
Surface Finishing	Gray Paint			
Material	Aluminum			

Outline Drawing [mm[inch]]

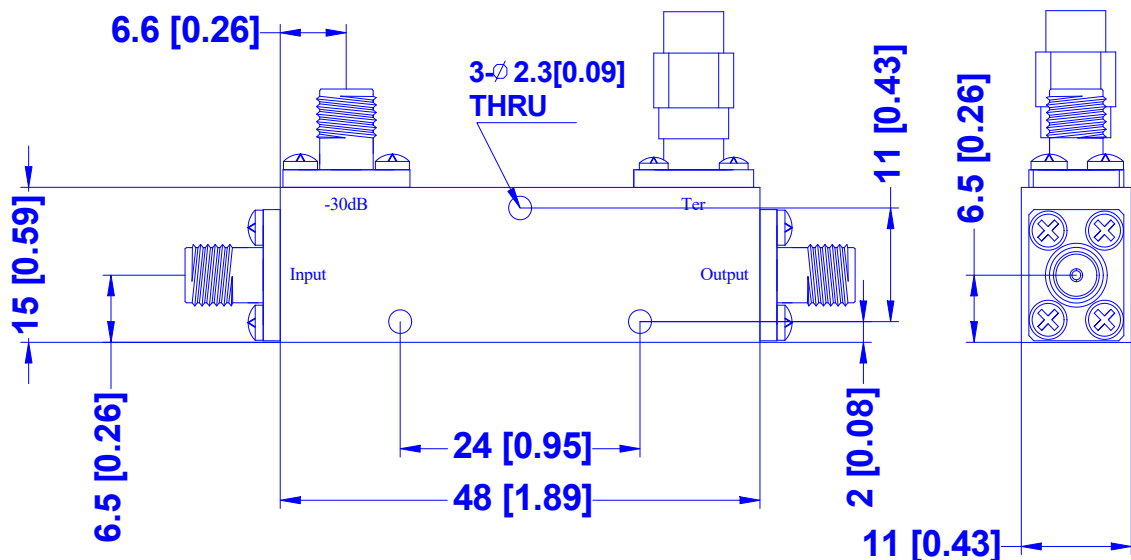

Tolerances ±0.5[0.02]