

TMDC-06004000-20K30 6-40 GHz, 20dB, 30W, 2.92mm Female

FEATURES

- ❖ Wide Band Operation 6-40 GHz
- ❖ Power Handle Capability up to 30W
- ❖ 20 dB Typical Coupling
- ❖ Low Insertion Loss

APPLICATIONS

- ❖ Frequency Measurements
- ❖ Signal Levelling, Signal Sampling
- ❖ Signal Injection
- ❖ Reflection Coefficient Measurements
- ❖ Measure incident and reflected power to determine VSWR

SPECIFICATIONS

Parameters	Min.	Typ.	Max.	Min.	Typ.	Max.	Min.	Typ.	Max.	Units
Frequency Range	6	-	26.5	26.5	-	40	40	-	43.5	GHz
Impedance	-	50	-	-	50	-	-	50	-	Ohms
Nominal Coupling	19	20	21	19	20	21	-	20	-	dB
Frequency Sensitivity	-	±0.5	±0.7	-	±0.4	±0.6	-	±0.3	-	dB
Directivity	12	15	-	10	14	-	-	10	-	dB
Insertion Loss(Excluding coupling loss)	-	-	0.8	-	-	1.0	-	1.0	-	dB
Insertion Loss(True)	-	0.7	0.9	-	0.9	1.0	-	1.0	-	dB
VSWR Primary	-	1.3	1.5	-	1.45	1.6	-	1.5	-	:1
VSWR Secondary	-	1.3	1.5	-	1.4	1.6	-	1.5	-	:1
Average Power	30									W
Peak Power	300(10% Duty Cycle, 1µs Pulse Width)									W
Operating Temperature	-40°C~+85°C									
Storage Temperature	-50°C~+105°C									
Input/Output Connectors	2.92mm female(Stainless Steel)									
Weight	30g max									
Surface Finishing	Gray Paint									
Material	Aluminum									

Outline Drawing [mm[inch]]

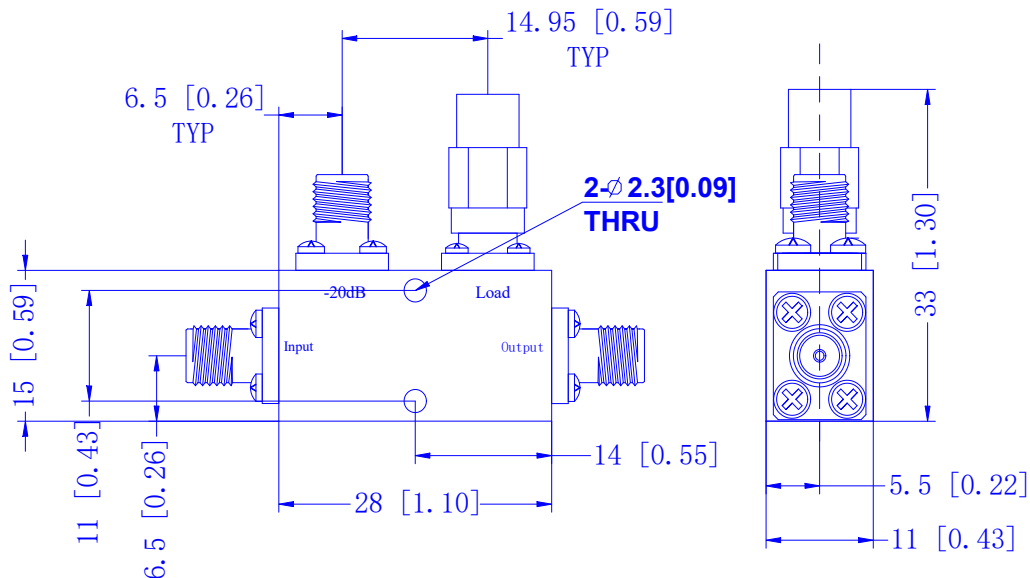

Tolerances ±0.5[0.02]