

TMDC-18002650-10S30 18-26.5 GHz, 10dB, 30W, SMA Female

FEATURES

- ❖ Wide Band Operation 18-26.5 GHz
- ❖ Power Handle Capability up to 30W
- ❖ 10 dB Typical Coupling
- ❖ Low Insertion Loss

APPLICATIONS

- ❖ Frequency Measurements
- ❖ Signal Levelling, Signal Sampling
- ❖ Signal Injection
- ❖ Reflection Coefficient Measurements
- ❖ Measure incident and reflected power to determine VSWR

SPECIFICATIONS

Parameters	Min.	Typ.	Max.	Units
Frequency Range	18	-	26.5	GHz
Impedance	-	50	-	Ohms
Nominal Coupling	9	10	11	dB
Frequency Sensitivity	-	±0.3	±0.5	dB
Directivity	13	15	-	dB
Insertion Loss(Excluding coupling loss)	-	-	1.1	dB
Insertion Loss(True)	-	1.3	1.5	dB
VSWR Primary	-	1.4	1.5	:1
VSWR Secondary	-	1.4	1.5	:1
Average Power	30			W
Peak Power	300(10% Duty Cycle, 1μs Pulse Width)			W
Operating Temperature	-40°C~+85°C			
Storage Temperature	-50°C~+105°C			
Input/Output Connectors	SMA female(Stainless Steel)			
Weight	25g			
Surface Finishing	Gray Paint			
Material	Aluminum			

Outline Drawing [mm[inch]]

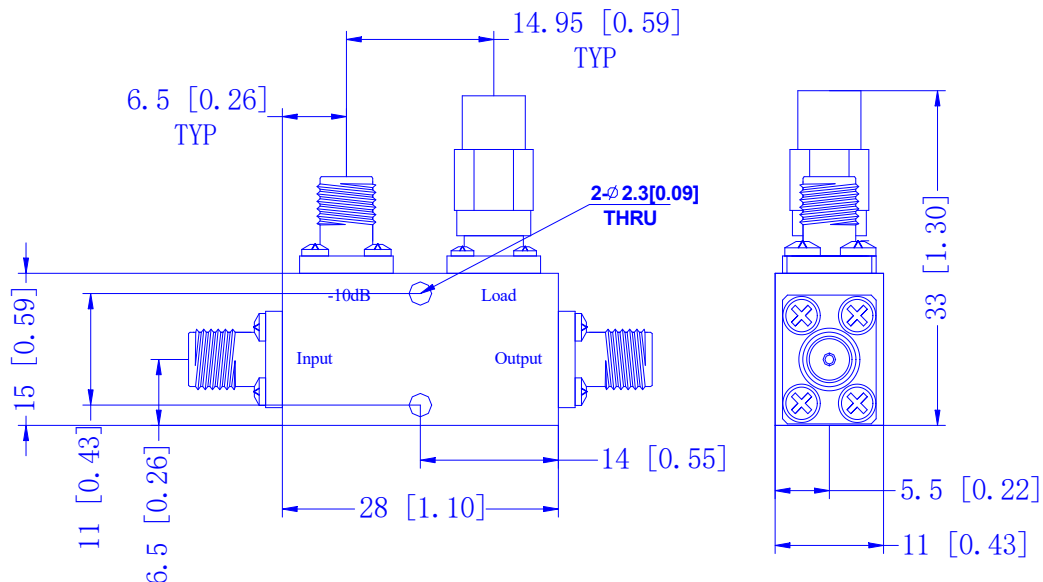

Tolerances ±0.5[0.02]