

**TMLA-08002650-1508-35 8-26.5 GHz, 15dB, P1dB 8dBm, N.F. 3.5dB**

**FEATURES**

- ❖ Wide Band Operation 8-26.5 GHz
- ❖ Small Signal Gain 15dB Minimum
- ❖ P1dB Output Power +8dBm Minimum
- ❖ Supply Voltage +5Vdc

**APPLICATIONS**

- ❖ Wireless Infrastructure
- ❖ Test and Measurement Instrument
- ❖ Radar and EW Systems
- ❖ Satellite Receiver

**SPECIFICATIONS**

Parameters	Min.	Typ.	Max.	Units
Frequency Range	8	-	26.5	GHz
Impedance	-	50	-	Ohms
Gain	15	-	-	dB
Gain Flatness	-	±1.5	-	dB
Noise Figure	-	3.5	-	dB
Spurious	-	-	-60	dBc
VSWR	-	1.5	-	:1
Output 1dB Compression Point(P1dB)	8	-	-	dBm
Supply Voltage	-	+5	-	V
Supply Current	-	100	-	mA
RF Input Power	-	-	+10	dBm
Operating Temperature	-20	-	+50	°C
Storage Temperature	-40	-	+85	°C
Humidity	-	95	-	%
Input/Output Connectors	2.92mm female			
Weight	50g			
Material	Aluminum			

**Outline Drawing [mm]**

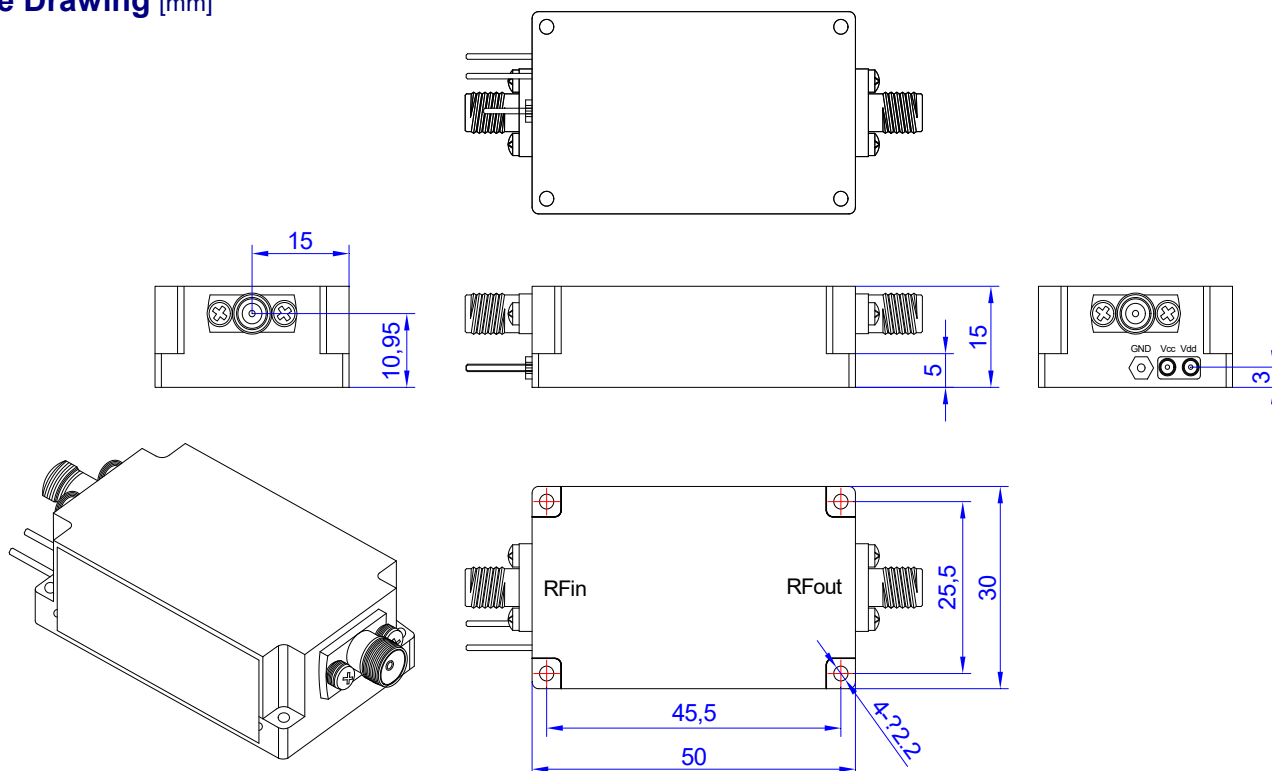

Tolerances ±0.1[0.004]