

**TMLA-18002650-4510-32 18-26.5 GHz, 45dB, P1dB 10dBm, N.F. 3.2dB**

**FEATURES**

- ❖ Wide Band Operation 18-26.5 GHz
- ❖ Small Signal Gain 45dB Minimum
- ❖ P1dB Output Power +10dBm Typical
- ❖ Supply Voltage +5Vdc

**APPLICATIONS**

- ❖ Wireless Infrastructure
- ❖ Test and Measurement Instrument
- ❖ Radar and EW Systems
- ❖ Satellite Receiver

**SPECIFICATIONS**

Parameters	Min.	Typ.	Max.	Units
Frequency Range	18	-	26.5	GHz
Impedance	-	50	-	Ohms
Gain	45	-	-	dB
Gain Flatness	-	±2.0	-	dB
Noise Figure	-	-	3.2	dB
Spurious	-	-	-60	dBc
VSWR	-	1.8	-	:1
Output 1dB Compression Point(P1dB)	-	10	-	dBm
Supply Voltage	-	+5	-	V
Supply Current	-	300	-	mA
RF Input Power	-	-	+10	dBm
Operating Temperature	-20	-	+60	°C
Storage Temperature	-55	-	+85	°C
Humidity	-	95	-	%
Input/Output Connectors	2.92mm female			
Weight	50g			
Material	Aluminum			

**Outline Drawing [mm]**

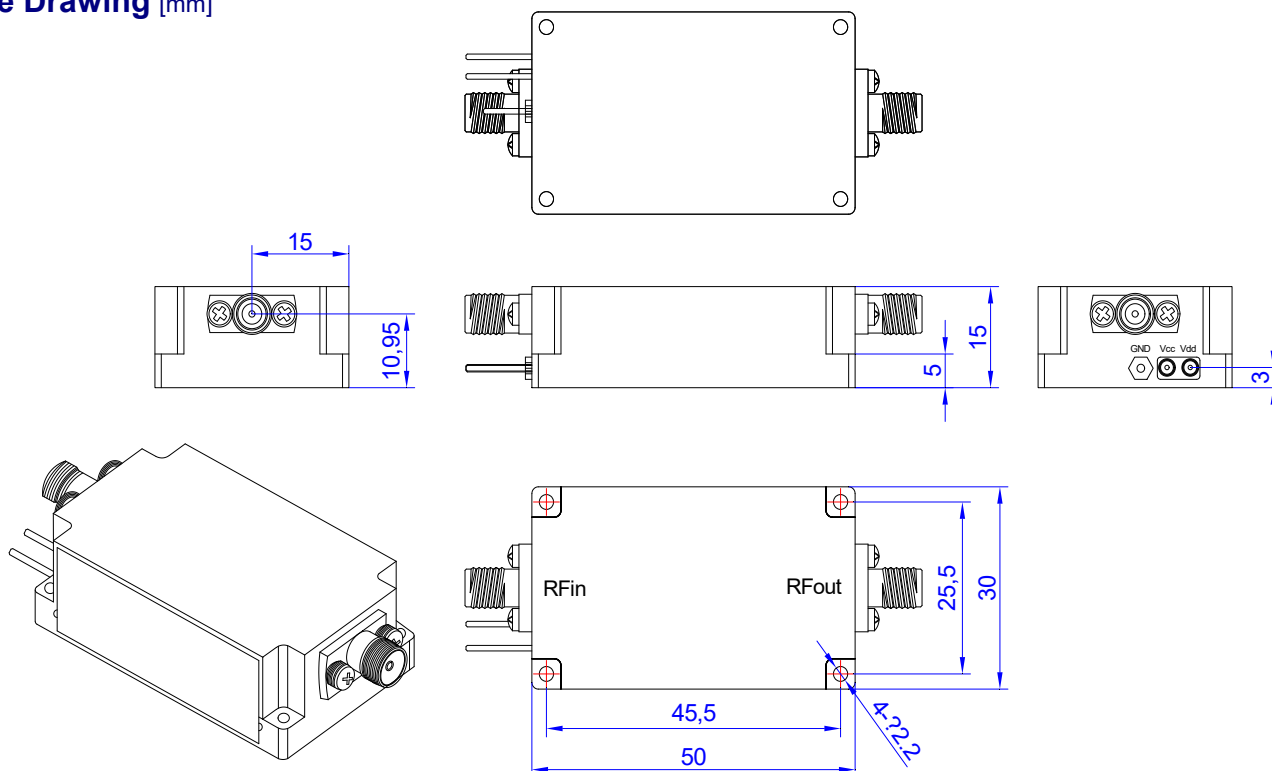

Tolerances ±0.1[0.004]