

TMHC90-04000800-50N 4.0-8.0 GHz, 50W, N Female

FEATURES

- ❖ Wide Band Operation 4-8 GHz
- ❖ Power Handle Capability up to 50W
- ❖ High Isolation Across Operational Band
- ❖ Low Insertion Loss
- ❖ Stable Performance Over Temperature

APPLICATIONS

- ❖ Commercial Wireless Communications
- ❖ Radar Systems
- ❖ Receivers Systems
- ❖ Antenna Beam Forming
- ❖ Test Labs

SPECIFICATIONS

Parameters	Min.	Typ.	Max.	Units
Frequency Range	4	-	8	GHz
Impedance	-	50	-	Ohms
Nominal Split	-	3.01	-	dB
Insertion Loss	-	-	0.8	dB
Isolation	18	-	-	dB
Amplitude Balance	-	-	±0.5	dB
Phase Balance	-	-	±5	Deg
VSWR	-	-	1.4	:1
Average Power	-	-	50	W
Peak Power	-	-	3	kW
Operating Temperature	-40	-	+85	°C
Storage Temperature	-50	-	+105	°C
Input/Output Connectors	N female			
Weight	150g			
Surface Finishing	Black/Blue Paint			
Material	Aluminum			

Outline Drawing [mm[inch]]

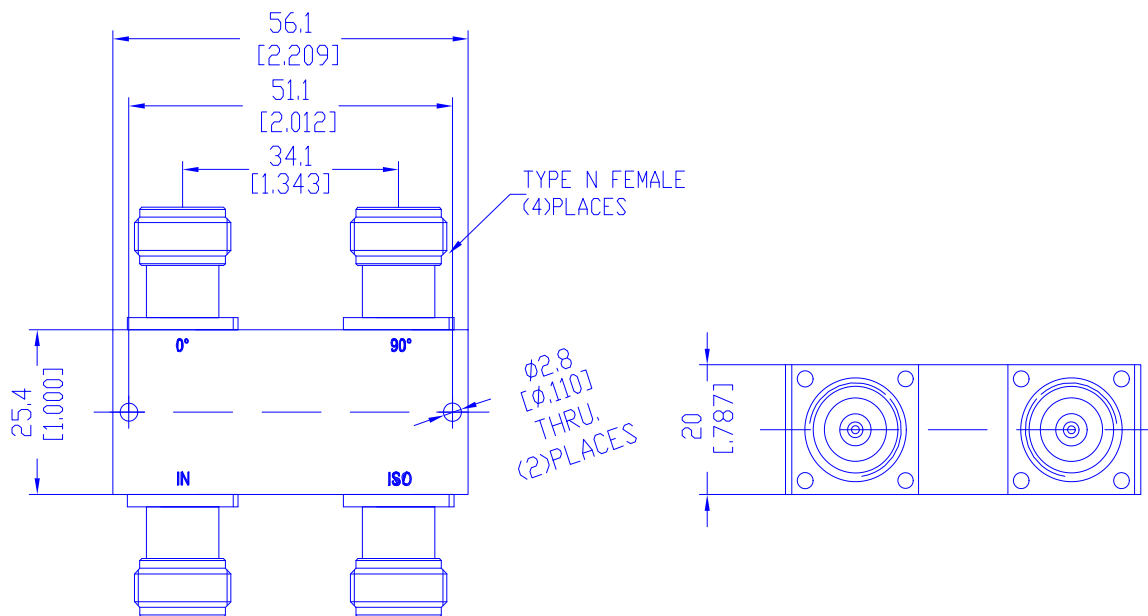

Tolerances ±0.5[0.02]