

TDDC-02000800-30S50 2-8 GHz, 30dB, 50W, SMA Female

FEATURES

- ❖ Wide Band Operation 2-8 GHz
- ❖ Power Handle Capability up to 50W
- ❖ 30 dB Typical Coupling
- ❖ Low Insertion Loss

APPLICATIONS

- ❖ Frequency Measurements
- ❖ Signal Levelling, Signal Sampling
- ❖ Signal Injection
- ❖ Reflection Coefficient Measurements
- ❖ Measure incident and reflected power to determine VSWR

SPECIFICATIONS

Parameters	Min.	Typ.	Max.	Units
Frequency Range	2	-	8	GHz
Impedance	-	50	-	Ohms
Nominal Coupling	29	30	31	dB
Frequency Sensitivity	-	-	±1.0	dB
Directivity	15	-	-	dB
Insertion Loss(Excluding coupling loss 0.01dB)	-	-	0.7	dB
VSWR Primary	-	-	1.3	:1
VSWR Secondary	-	-	1.3	:1
Power Handling	Incident	-	50	W
	Reflected	-	50	W
Operating Temperature	-40	-	+85	°C
Storage Temperature	-50	-	+105	°C
Input/Output Connectors	SMA-Female			
Weight	90g			
Dimensions	88mm×19.05mm×11mm			
Surface Finishing	Black/Blue Paint			
Material	Aluminum			

Outline Drawing [mm][inch]

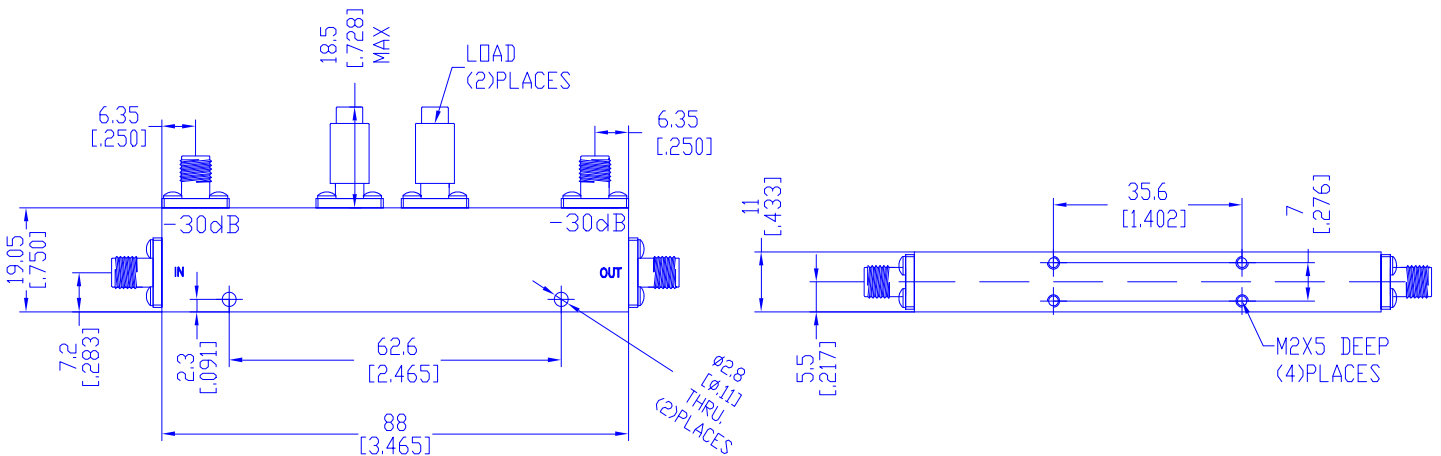

Tolerances ±0.5[0.02]