

TDDC-08002650-10K30 8-26.5 GHz, 10dB, 30W, 2.92mm Female

FEATURES

- ❖ Wide Band Operation 8-26.5 GHz
- ❖ Power Handle Capability up to 30W
- ❖ 10 dB Typical Coupling
- ❖ Low Insertion Loss

APPLICATIONS

- ❖ Frequency Measurements
- ❖ Signal Levelling, Signal Sampling
- ❖ Signal Injection
- ❖ Reflection Coefficient Measurements
- ❖ Measure incident and reflected power to determine VSWR

SPECIFICATIONS

Parameters	Min.	Typ.	Max.	Units
Frequency Range	8	-	26.5	GHz
Impedance	-	50	-	Ohms
Nominal Coupling	9	10	11	dB
Frequency Sensitivity	-	±0.7	±1.0	dB
Directivity	10	12	-	dB
Insertion Loss(Excluding coupling loss)	-	-	1.6	dB
VSWR Primary	-	1.5	1.6	:1
VSWR Secondary	-	1.5	1.6	:1
Power Handling	Average	-	30	W
	Peak	-	300	W
Operating Temperature	-40	-	+85	°C
Storage Temperature	-50	-	+105	°C
Input/Output Connectors	2.92mm-Female			
Weight	50g			
Dimensions	56mm×15mm×11mm			
Surface Finishing	Gray Paint			
Material	Aluminum			

Outline Drawing [mm]

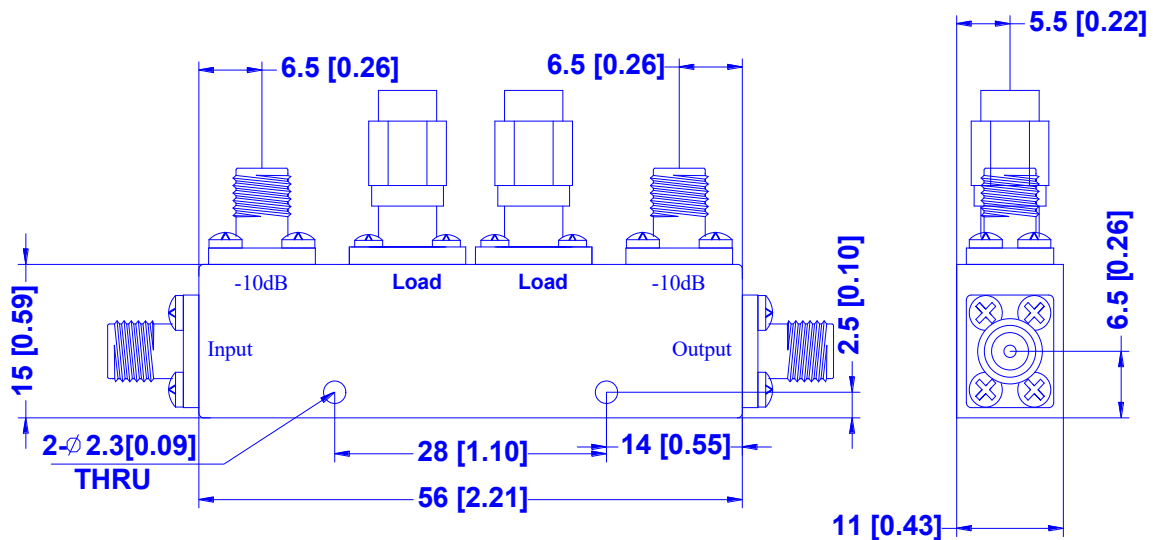

Tolerances ±0.5[0.02]