

Datasheet

Model Number : TMPC110S45-100

Penprobe, DC-110GHz, GSG Config., 1.0mm-Female

Specifications

Frequency Range	DC-110 GHz
Connector	1.0mm-Female
Impedance	50 Ohms
Return Loss	10dB min
Insertion Loss	1.5dB max
Equiped Connector Angle	45°
Contact Configuration	GSG
Probe Pitch	100μm
Probe Tip Width	30μm
Recommend Overtravel	50μm~75μm
Material	Aluminum Alloy
Probe Tip	BeCu, Gold Plated
Operating Temperature	-45°C~+85°C
RoHS Status	RoHS Compliant

Outline Drawing[mm]:

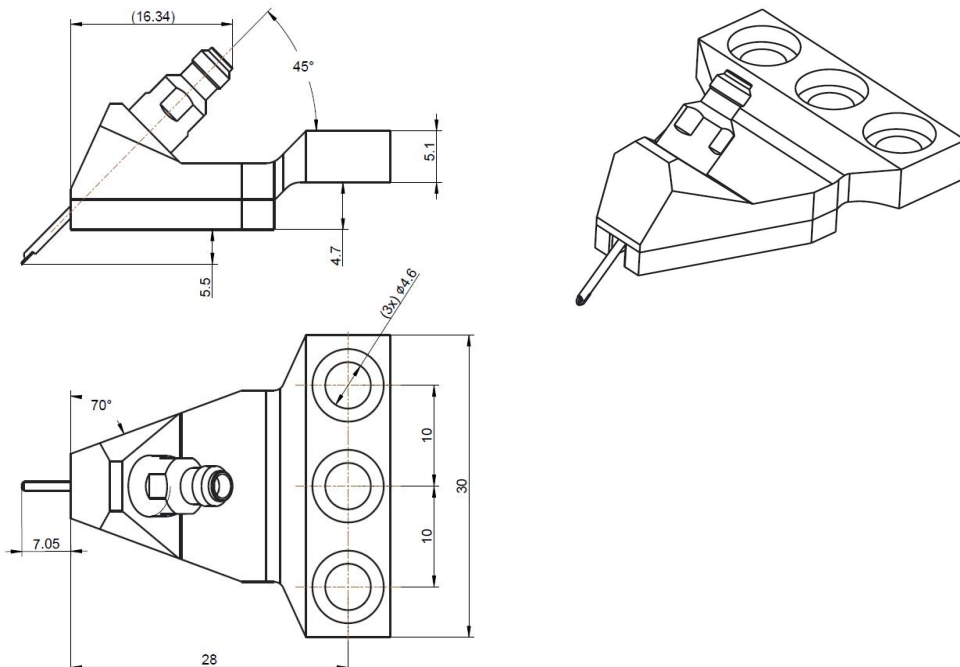

Tolerance: ±0.25