



Datasheet

Model Number : TMPC50S45-150

Penprobe, DC-50GHz, GSG Config., 2.4mm-Female

Specifications

Frequency Range	DC-50 GHz
Connector	2.4mm-Female
Impedance	50 Ohms
Return Loss	16dB min
Insertion Loss	0.8dB max
Equiped Connector Angle	45°
Contact Configuration	GSG
Probe Pitch	150μm
Probe Tip Width	30μm
Recommend Overtravel	50μm~75μm
Material	Aluminum Alloy
Probe Tip	BeCu, Gold Plated
Operating Temperature	-45°C~+85°C
RoHS Status	RoHS Compliant

Outline Drawing[mm]:

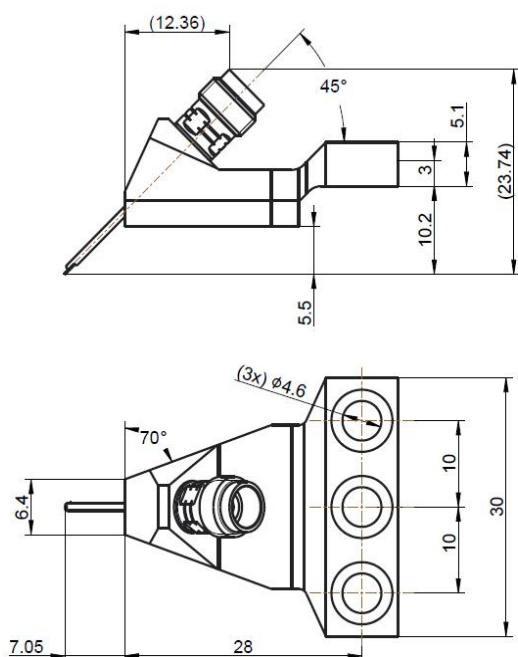

Tolerance: ±0.25