



## Datasheet

Model Number : TMPC40S45-300

### Penprobe, DC-40GHz, GSG Config., 2.92mm-Female

## Specifications

Frequency Range	DC-40 GHz
Connector	2.92mm-Female
Impedance	50 Ohms
Return Loss	18dB min
Insertion Loss	0.7dB max
Equiped Connector Angle	45°
Contact Configuration	GSG
Probe Pitch	300μm
Probe Tip Width	30μm
Recommend Overtravel	50μm~75μm
Material	Aluminum Alloy
Probe Tip	BeCu, Gold Plated
Operating Temperature	-45°C~+85°C
RoHS Status	RoHS Compliant

### Outline Drawing[mm]:

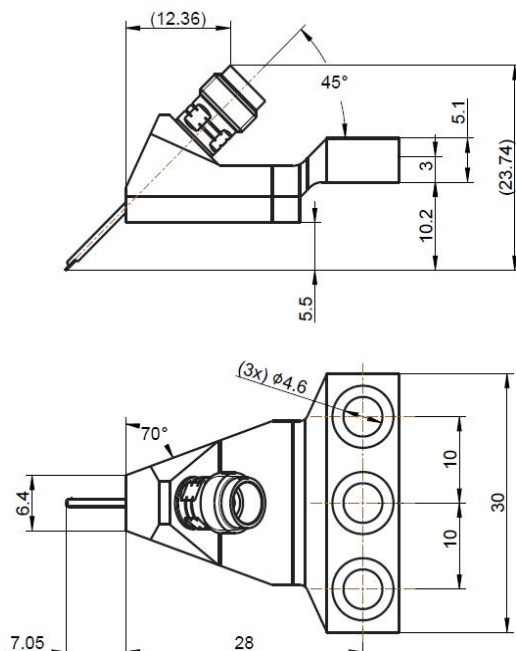

Tolerance: ±0.25