



Datasheet

Model Number : TMPC67SGS45-125

Penprobe, DC-67GHz, GSGSG Config., 1.85mm-Female

Specifications

Frequency Range	DC-67 GHz
Connector	1.85mm-Female
Impedance	50 Ohms
Return Loss	12dB min@DC-67 GHz (based on 125 μ m pitch)
Insertion Loss	1.2dB max
Contact Resistance	<50 Ω , Au pads; <75 Ω , Al pads
Equiped Connector Angle	45°
Contact Configuration	GSGSG
Probe Pitch	125 μ m
Recommend Overtravel	50 μ m~75 μ m
Material	Aluminum Alloy
Probe Tip	BeCu, Gold Plated
Insulator	mmWave Material
Operating Temperature	-45°C~+85°C
RoHS Status	RoHS Compliant

Outline Drawing[mm]:

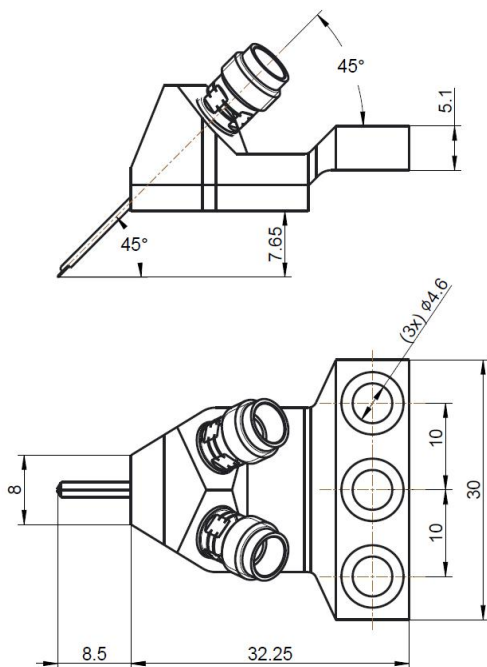

Tolerance: ± 0.25