

TMDC-00400390-30N500 0.4-3.9 GHz, 30dB, 500W, N-Female

FEATURES

- ❖ Wide Band Operation 0.4-3.9 GHz
- ❖ Power Handle Capability up to 500W
- ❖ 30 dB Typical Coupling
- ❖ Low Insertion Loss

APPLICATIONS

- ❖ Frequency Measurements
- ❖ Signal Levelling, Signal Sampling
- ❖ Signal Injection
- ❖ Reflection Coefficient Measurements
- ❖ Measure incident and reflected power to determine VSWR

SPECIFICATIONS

Parameters	Min.	Typ.	Max.	Units
Frequency Range	0.4	-	3.9	GHz
Impedance	-	50	-	Ohms
Nominal Coupling	28.2	30	31.8	dB
Directivity	20	-	-	dB
Insertion Loss	-	-	0.5	dB
VSWR Primary	-	-	1.2	:1
Average Power	-	-	500	W
Operating Temperature	-40	-	+85	°C
Storage Temperature	-50	-	+100	°C
Input/Output Connectors	N-Female			
Connector Body	Nickel Plated Brass			
Weight	330g max			
Dimensions	186×43.7×23mm			
Material	Aluminum			

Outline Drawing [mm]

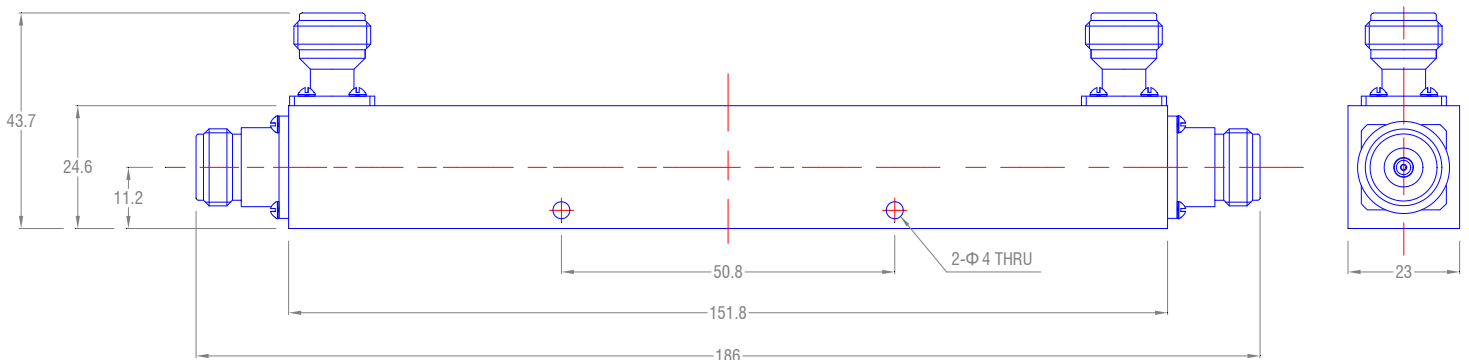

Tolerances ±0.5