

PART NUMBER TMCC-40004500	REV.	DATE	COMMENTS	INITIAL
	1	2021/6/25	ENGINEERING RELEASE	

Specifications

Frequency Range	40-45GHz
Impedance	50 Ohm
Insertion Loss	1.3dB typ, 1.6dB max
VSWR	1.5 typ, 1.6 max
Isolation	14dB min, 15dB typ
Forward Power(CW)	10W
Reverse Power	10W
Rotation	Clockwise
Connectors	2.4mm-Female
Temperature Range	-40°C~+85°C
Surface Finish	Nickel Plated
Case Material	Aluminum Alloy
Weight	90g

RoHS Compliant

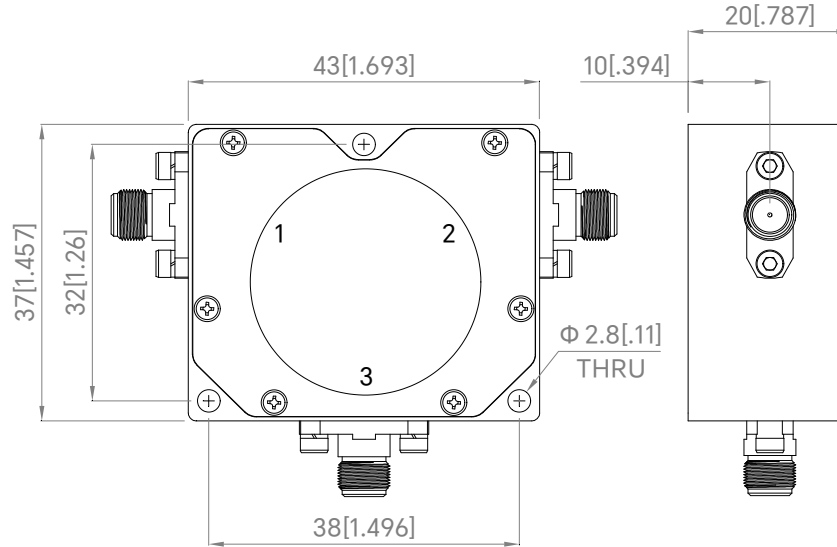

Drawing not to scale, units:mm



www.titan-microwave.com
 Tel: +86 130 866 58398
 Email: sales@titan-microwave.com
 chris@titan-microwave.com

PART NUMBER TMCC-40004500		DESCRIPTION Coaxial Circulator, 40-45GHz, 10W 2.4mm-Female
CAGE CODE	SIGNATURE _____	
EXCEPT AS OTHERWISE PROVIDED BY CONTRACTOR THIS DRAWING OR SPECIFICATION IS PROPERTY OF TITAN MICROWAVE INC. IT IS ISSUED IN STRICT CONFIDENCE AND SHALL NOT BE REPRODUCED OR USED AS THE BASIS.		