

PART NUMBER TWDC19D27C40	REV.	DATE	COMMENTS	INITIAL
	1	2021/6/19	ENGINEERING RELEASE	

SPECIFICATIONS

Frequency Range39.2-59.6GHz
 Coupling40±1.0dB
 Directivity 27dB min
 VSWR Primary 1.1:1 max
 VSWR Secondary 1.15:1 max
 Impedance 50 Ohms
 Waveguide Type WR-19
 Flange Type FUGP500 Circular Flange
 Waveguide Body Copper, Glod Plated
 Dimensions 105.7×Φ28.6mm

RoHS Compliant

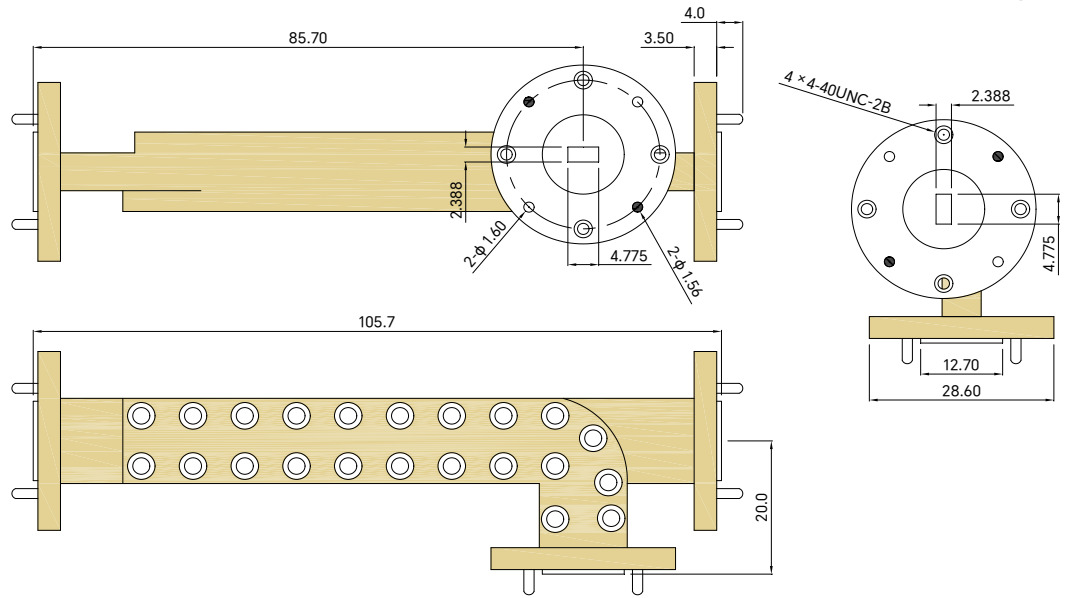

Drawing not to scale, units:mm



www.titan-microwave.com
 Tel: +86 185 8328 2993
 Email: sales@titan-microwave.com
 chris@titan-microwave.com

PART NUMBER TWDC19D27C40		DESCRIPTION Waveguide Directional Coupler, WR-19 39.2-59.6GHz, Coupling 40 ± 1.0dB
CAGE CODE	SIGNATURE	
EXCEPT AS OTHERWISE PROVIDED BY CONTRACTOR THIS DRAWING OR SPECIFICATION IS PROPERTY OF TITAN MICROWAVE INC. IT IS ISSUED IN STRICT CONFIDENCE AND SHALL NOT BE REPRODUCED OR USED AS THE BASIS.		