

PART NUMBER
TWGC90C40N

REV.	DATE	COMMENTS	INITIAL
1	2021/4/16	ENGINEERING RELEASE	

SPECIFICATIONS

Frequency Range 9.25-9.55GHz
 Nominal Coupling 40±0.2dB
 Directivity 20dB min
 VSWR Primary 1.1:1 max
 VSWR Secondary 1.25:1 max
 Impedance 50 Ohms
 Waveguide Type WR-90
 Flange Type FBM100(PBR) Flange
 Coupling Port N-Female
 Waveguide Body Aluminum, Gray Painted
 Connector Body Stainless Steel, Passivated
 Dimensions 123.5×100mm

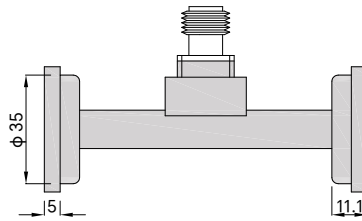

RoHS Compliant

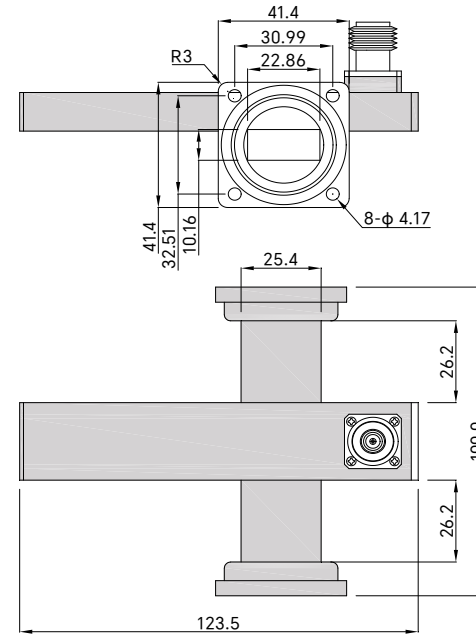

Drawing not to scale, units:mm



www.titan-microwave.com
 Tel: +86 185 8328 2993
 Email: sales@titan-microwave.com
 chris@titan-microwave.com

PART NUMBER TWGC90C40N		DESCRIPTION Waveguide Directional Cross Coupler, 9.25~9.55GHz Coupling 40 ± 0.2dB, WR-90, N-Female
CAGE CODE	SIGNATURE _____	
EXCEPT AS OTHERWISE PROVIDED BY CONTRACTOR THIS DRAWING OR SPECIFICATION IS PROPERTY OF TITAN MICROWAVE INC. IT IS ISSUED IN STRICT CONFIDENCE AND SHALL NOT BE REPRODUCED OR USED AS THE BASIS.		