

PART NUMBER
WGC340-6060-D22N

REV.	DATE	COMMENTS	INITIAL
1	2021/7/30	ENGINEERING RELEASE	

SPECIFICATIONS

- Frequency Range 2.4-2.5GHz
- Coupling 60±0.5dB
- Directivity 22dB min
- VSWR Primary 1.1:1 max
- VSWR Secondary 1.2:1 max
- Impedance 50 Ohms
- Waveguide Type WR-340
- Flange Type FDP26(UDR) Flange
- Coupled Port N-Female
- Waveguide Body Aluminum, Grey Painted
- Dimensions 148(L)×138.1(W)×95.3(H)mm

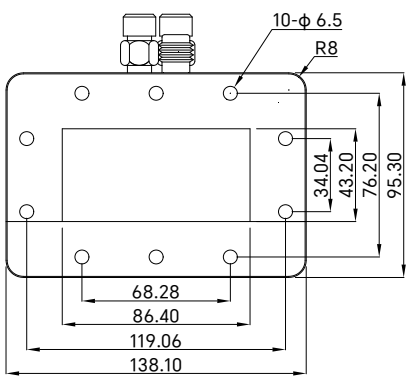

RoHS Compliant

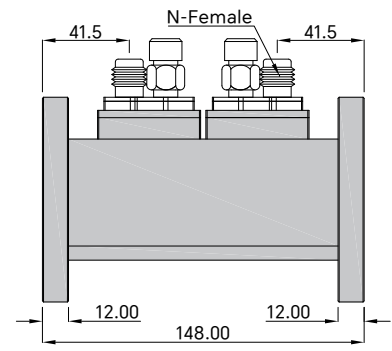
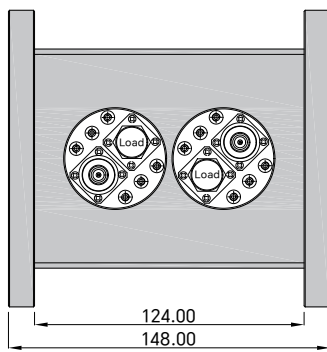

Drawing not to scale, units:mm



www.titan-microwave.com
Tel: +86 185 8328 2993
Email: sales@titan-microwave.com
chris@titan-microwave.com

PART NUMBER WGC340-6060-D22N		DESCRIPTION Waveguide Dual Directional Loop Coupler WR-340, 2.4~2.5GHz, 60 ± 0.5dB, N-Female
CAGE CODE	SIGNATURE	
EXCEPT AS OTHERWISE PROVIDED BY CONTRACTOR THIS DRAWING OR SPECIFICATION IS PROPERTY OF TITAN MICROWAVE INC. IT IS ISSUED IN STRICT CONFIDENCE AND SHALL NOT BE REPRODUCED OR USED AS THE BASIS.		