

Terminated, Normally Open/Latching

❖ Features

- DC-18 GHz
- Low VSWR
- Low Loss
- High Isolation
- SMA(f) connectors

❖ RF Characteristics

Frequency	Ins. Loss	Isolation	VSWR	Average Power
GHz	dB	dB		W
DC~6	0.3	70	1.3	80
6~12	0.4	60	1.4	60
12~18	0.5	50	1.5	50

Operating Voltage/Coil Current

Operating Voltage(V)	12	24	28
Current (mA)			
Normally Open	300	200	180
Latching	320	200	180
Latching(Reset)	3200	2000	1800

TTL	Low(V)	High	
	0~0.3	3~5V	1.4mA
Indicator Rating	V(max)	mA(max)	Ω(max)
	50	100	15

※ +Vdc and GND must be connected to operate



❖ Specifications

Frequency Range	DC-18 GHz
Impedance	50 Ohms
Switching Sequence	Break Before Make
Switching Time	15mS max
Operating Life	2 million cycles
Shock, Non-operating	50G, 1/2 Sine, 11ms
Vibration, Operating	20-2000Hz, 10G RMS
RF Interface	SMA female
Control Connector	D-SUB 15/26Pin Male
Storage Temperature	-55°C~+85°C
Operating Temperature	-25°C~+65°C (Standard)
	-45°C~+85°C (Extended Temp. 1)
	-55°C~+85°C (Extended Temp. 2)
Weight	405g

❖ Outline Drawing[mm[inch]]

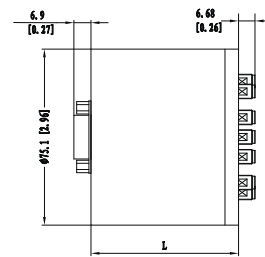
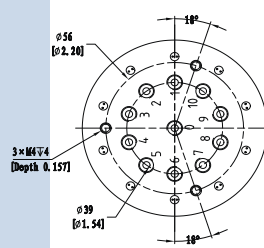

L=61.5(W.O. TTL / TTL / IND)

Mounting Bracket

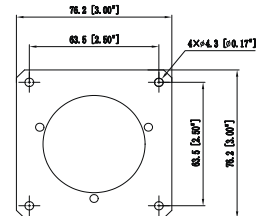
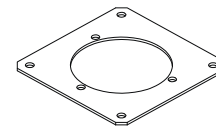
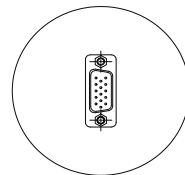

❖ Ordering Information

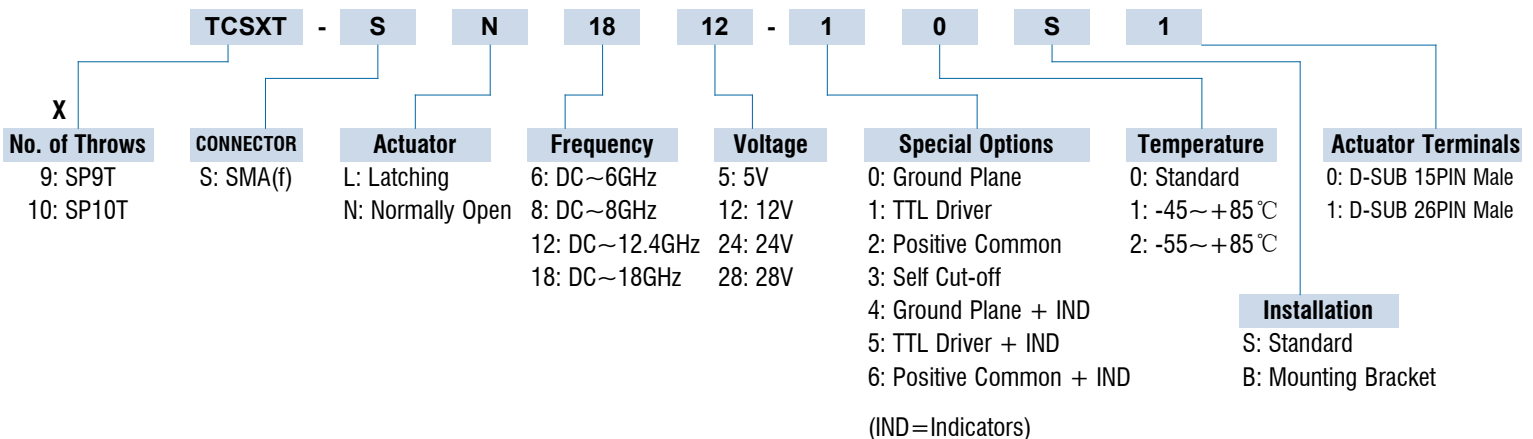

Please feel free to contact us for more information regarding additional options and custom configurations

Truth Table

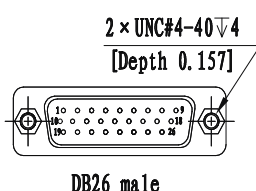
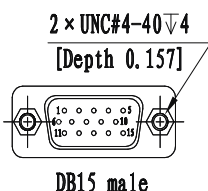

LATCHING W/O TTL

D-SUB 15/26Pin Male		RF Path	
Pin No.	Description	SP9T	SP10T
1	V1	RF 1-0	RF 1-0
2	V2	RF 2-0	RF 2-0
3	V3	RF 3-0	RF 3-0
4	V4	RF 4-0	RF 4-0
5	V5	RF 5-0	RF 5-0
6	V6	RF 6-0	RF 6-0
7	V7	RF 7-0	RF 7-0
8	V8	RF 8-0	RF 8-0
9	V9	RF 9-0	RF 9-0
10	V10	-	RF 10-0
11	V(Reset)	-	-
12	GND	-	-
13	IND 1	RF 1-0	RF 1-0
14	IND 2	RF 2-0	RF 2-0
15	IND 3	RF 3-0	RF 3-0
16	IND 4	RF 4-0	RF 4-0
17	IND 5	RF 5-0	RF 5-0
18	IND 6	RF 6-0	RF 6-0
19	IND 7	RF 7-0	RF 7-0
20	IND 8	RF 8-0	RF 8-0
21	IND 9	RF 9-0	RF 9-0
22	IND 10	-	RF 10-0
23	IND COM	-	-
24	VDC	-	-
25~26	N/A	-	-

LATCHING W/ TTL

D-SUB 15/26Pin Male		RF Path	
Pin No.	Description	SP9T	SP10T
1	TTL	RF 1-0	RF 1-0
2	TTL	RF 2-0	RF 2-0
3	TTL	RF 3-0	RF 3-0
4	TTL	RF 4-0	RF 4-0
5	TTL	RF 5-0	RF 5-0
6	TTL	RF 6-0	RF 6-0
7	TTL	RF 7-0	RF 7-0
8	TTL	RF 8-0	RF 8-0
9	TTL	RF 9-0	RF 9-0
10	TTL	-	RF 10-0
11	TTL(Reset)	-	-
12	VDC	-	-
13	GND	-	-
14	IND 1	RF 1-0	RF 1-0
15	IND 2	RF 2-0	RF 2-0
16	IND 3	RF 3-0	RF 3-0
17	IND 4	RF 4-0	RF 4-0
18	IND 5	RF 5-0	RF 5-0
19	IND 6	RF 6-0	RF 6-0
20	IND 7	RF 7-0	RF 7-0
21	IND 8	RF 8-0	RF 8-0
22	IND 9	RF 9-0	RF 9-0
23	IND 10	-	RF 10-0
24	IND COM	-	-
25~26	N/A	-	-

NORMALLY OPEN W/O TTL

D-SUB 15/26Pin Male		RF Path	
Pin No.	Description	SP9T	SP10T
1	V1	RF 1-0	RF 1-0
2	V2	RF 2-0	RF 2-0
3	V3	RF 3-0	RF 3-0
4	V4	RF 4-0	RF 4-0
5	V5	RF 5-0	RF 5-0
6	V6	RF 6-0	RF 6-0
7	V7	RF 7-0	RF 7-0
8	V8	RF 8-0	RF 8-0
9	V9	RF 9-0	RF 9-0
10	V10	-	RF 10-0
11	GND	-	-
12	IND 1	RF 1-0	RF 1-0
13	IND 2	RF 2-0	RF 2-0
14	IND 3	RF 3-0	RF 3-0
15	IND 4	RF 4-0	RF 4-0
16	IND 5	RF 5-0	RF 5-0
17	IND 6	RF 6-0	RF 6-0
18	IND 7	RF 7-0	RF 7-0
19	IND 8	RF 8-0	RF 8-0
20	IND 9	RF 9-0	RF 9-0
21	IND 10	-	RF 10-0
22	IND COM	-	-
23	VDC	-	-
24~26	N/A	-	-

NORMALLY OPEN W/ TTL

D-SUB 15/26Pin Male		RF Path	
Pin No.	Description	SP9T	SP10T
1	TTL	RF 1-0	RF 1-0
2	TTL	RF 2-0	RF 2-0
3	TTL	RF 3-0	RF 3-0
4	TTL	RF 4-0	RF 4-0
5	TTL	RF 5-0	RF 5-0
6	TTL	RF 6-0	RF 6-0
7	TTL	RF 7-0	RF 7-0
8	TTL	RF 8-0	RF 8-0
9	TTL	RF 9-0	RF 9-0
10	TTL	-	RF 10-0
11	VDC	-	-
12	GND	-	-
13	IND 1	RF 1-0	RF 1-0
14	IND 2	RF 2-0	RF 2-0
15	IND 3	RF 3-0	RF 3-0
16	IND 4	RF 4-0	RF 4-0
17	IND 5	RF 5-0	RF 5-0
18	IND 6	RF 6-0	RF 6-0
19	IND 7	RF 7-0	RF 7-0
20	IND 8	RF 8-0	RF 8-0
21	IND 9	RF 9-0	RF 9-0
22	IND 10	-	RF 10-0
23	IND COM	-	-
24~26	N/A	-	-