

REV	DESCRIPTION OF REVISION	By	DATE	APPROVED
A	INITIAL RELEASE	C. Cai	2023/7/11	C. Chen

## TECHNICAL DATA

### ► Electrical Data

Pass Band Frequency	DC-48MHz
Pass Band Insertion Loss	≤1.0dB
Pass Band VSWR	≤1.5:1
Stop Band Rejection	≥35dB@70~90MHz, ≥58dB@90~200MHz
Impedance	50 Ohms
Power Handling	2W

### ► Mechanical Data

Dimensions	30×12×10mm
Connectors	SMA-Female(stainless steel)
Surface Finish	Silver Plated
Body	Copper H62

### ► Environmental Data

Temperature Range	-40℃~+85℃(design assurance)
-------------------	-----------------------------

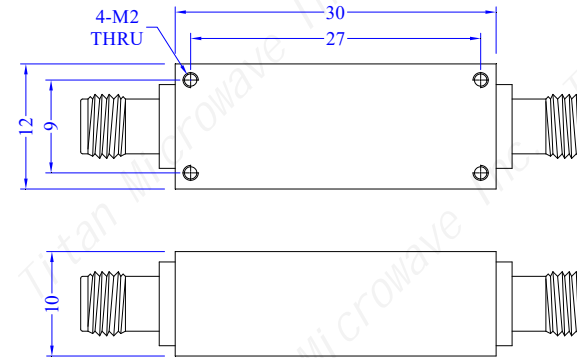

DRAWN: L. Ma 11/07/23		
ENGINEER: J. Zhu 11/07/23		
APPROVED: C. Chen 11/07/23		
TOLERANCE UNLESS OTHERWISE SPECIFIED		
x	±0.50	[0.019"]
.x	±0.20	[0.008"]
.xx	±0.10	[0.004"]
ANGLES	±1°	

**TITLE:**  
Low Pass Filter, DC-48MHz, Stop Band Rejection 58dB, 2W, SMA-Female

**PART No.:**  
TLF-48-58S



[www.titan-microwave.com](http://www.titan-microwave.com)



DIMENSIONS IN MILLIMETERS(mm)

<b>SIZE:</b> A4	<b>SCALE:</b>	<b>SHEET:</b> 1/1	<b>REV:</b> A
--------------------	---------------	----------------------	------------------

**Notes:**

- ALL SPECIFICATIONS ARE SUBJECT TO CHANGE WITHOUT NOTICE AT ANY TIME
- CUSTOMER OUTLINE DRAWING FOR REFERENCE ONLY