

REV	DESCRIPTION OF REVISION	By	DATE	APPROVED
A	INITIAL RELEASE	C. Cai	2023/7/11	C. Chen

TECHNICAL DATA

► Electrical Data

Pass Band Frequency	DC-11MHz
Pass Band Insertion Loss	≤1.0dB
Pass Band VSWR	≤1.5:1
Stop Band Rejection	≥25dB@19~24MHz, ≥45dB@24~200MHz
Impedance	50 Ohms
Power Handling	2W

► Mechanical Data

Dimensions	30×12×10mm
Connectors	SMA-Female(stainless steel)
Surface Finish	Silver Plated
Body	Copper H62

► Environmental Data

Temperature Range	-40℃~+85℃(design assurance)
-------------------	-----------------------------

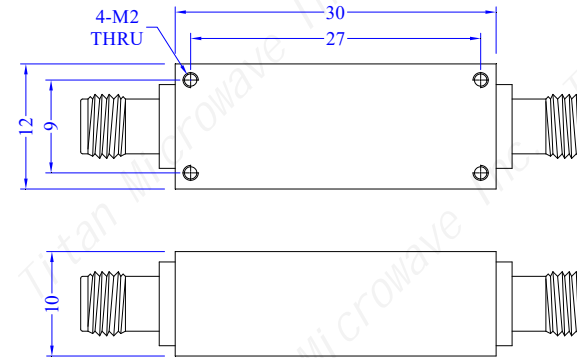

DRAWN: L. Ma 11/07/23		
ENGINEER: J. Zhu 11/07/23		
APPROVED: C. Chen 11/07/23		
TOLERANCE UNLESS OTHERWISE SPECIFIED		
x	±0.50	[0.019"]
.x	±0.20	[0.008"]
.xx	±0.10	[0.004"]
ANGLES	±1°	

TITLE:
Low Pass Filter, DC-
11MHz, Stop Band
Rejection 45dB, 2W,
SMA-Female

PART No.:
TLF-11-45S



www.titan-microwave.com



DIMENSIONS IN MILLIMETERS(mm)

SIZE: A4	SCALE:	SHEET: 1/1	REV: A
--------------------	---------------	----------------------	------------------

Notes:

- ALL SPECIFICATIONS ARE SUBJECT TO CHANGE WITHOUT NOTICE AT ANY TIME
- CUSTOMER OUTLINE DRAWING FOR REFERENCE ONLY