

REV	DESCRIPTION OF REVISION	By	DATE	APPROVED
A	INITIAL RELEASE	C. Cai	2024/5/17	C. Chen

TECHNICAL DATA

► Electrical Data

Stop Band Frequency	6525~6875MHz
Stop Band Attenuation	≥40dB
Pass Band Frequency	DC~6475MHz & 6975~18000MHz
Pass Band Insertion Loss	≤3.0dB
Pass Band VSWR	≤2.0:1
Power Handling	10W
Impedance	50 Ohms

► Mechanical Data

Dimensions	120×21×16mm
Connectors	SMA-Female
Surface Finish	Black Painted

► Environmental Data

Operating Temperature	-30℃~+70℃
Storage Temperature	-55℃~+85℃

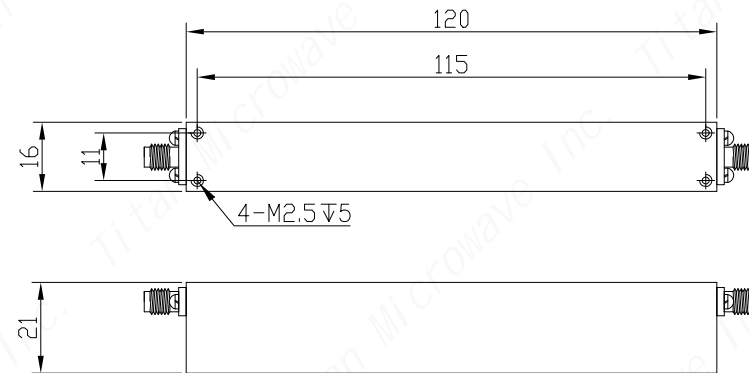

DRAWN: L. Ma 17/05/24		
ENGINEER: J. Zhu 17/05/24		
APPROVED: C. Chen 17/05/24		
TOLERANCE UNLESS OTHERWISE SPECIFIED		
x	±0.50	[0.019"]
.x	±0.20	[0.008"]
.xx	±0.10	[0.004"]
ANGLES	±1°	

TITLE:
Band Reject Filter,
6.525~6.875GHz, Stop
Band Rejection 40dB,
10W, SMA-Female

PART No.:
TRF-06520687-40S

成都巨人微波
TITAN MICROWAVE INC.
- A Professional RF & Microwave Components Supplier -

www.titan-microwave.com



DIMENSIONS IN MILLIMETERS(mm)

SIZE: A4	SCALE:	SHEET: 1/1	REV: A
-------------	--------	---------------	-----------

Notes:

- ALL SPECIFICATIONS ARE SUBJECT TO CHANGE WITHOUT NOTICE AT ANY TIME
- CUSTOMER OUTLINE DRAWING FOR REFERENCE ONLY