

Flanged Termination

General Specifications

- **Frequency Range:** DC to 6GHz
- **Nominal Impedance:** 50 Ohms
- **Resistance Tolerance:** $\pm 5\%$
- **VSWR:** 1.25 max
- **Power:** 60W
- **Temperature Coefficient:** $< 150\text{ppm}/^\circ\text{C}$
- **Substrate Material:** Beryllium Oxide(BeO)
- **Cap Material:** Aluminum Oxide(Al_2O_3)
- **Flange:** Nickel-plated Copper
- **Lead:** 99.99% Sterling Silver
- **Resistance Technology:** Thick Film
- **Operating Temperature:** $-55^\circ\text{C} \sim +150^\circ\text{C}$

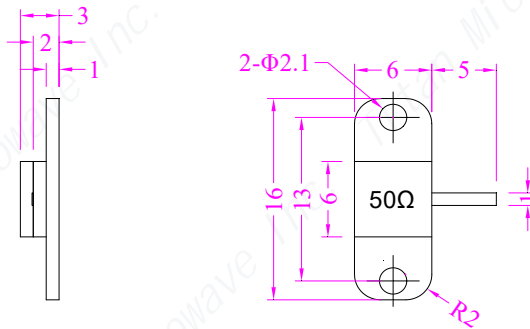
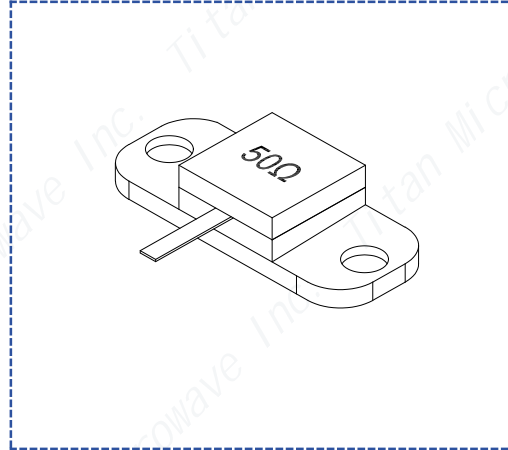

Dimensions tolerance: 5% unless otherwise specified

Ordering Information:

TFMT 1606D - 6 B 60 TM 2

Titan Microwave
Flanged Mount Termination

Case Size

Frequency Range(GHz)

Substrate Material
B: Beryllium Oxide(BeO)

Power Rating(W)

TM: Alumina Cap

DC Resistance Tolerance

No Designation for $\pm 5\%$
2= $\pm 2\%$; 1= $\pm 1\%$

Installation Method

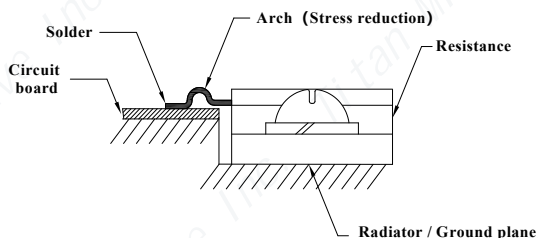

Derating Curve

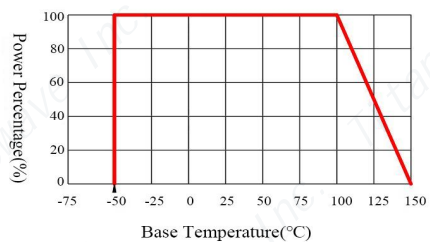

Actual performance could be limited by the solder properties of the application