

Flanged Resistor

General Specifications

- **Power:** 60W
- **Resistance Range:** 10~2000 Ohms
- **Resistance Tolerance:** ±5% standard, 1% and 2% available
- **Capacitance:** 2.6PF@100Ω
- **Temperature Coefficient:** <150ppm/°C
- **Substrate Material:** Beryllium Oxide(BeO)
- **Cover Material:** Aluminum Oxide(Al₂O₃)
- **Flange Material:** Brass
- **Lead:** 99.99% Sterling Silver
- **Resistance Technology:** Thick Film
- **Operating Temperature:** -55°C~+150°C

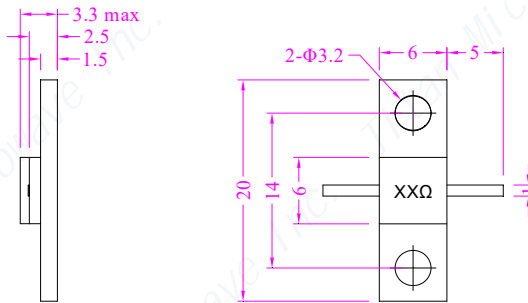
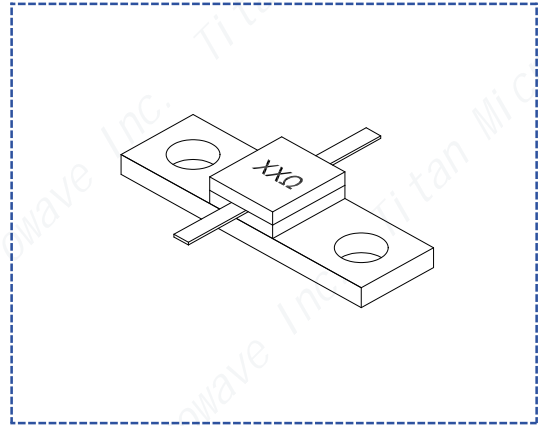

Dimensions tolerance: 5%
 unless otherwise specified

Ordering Information:

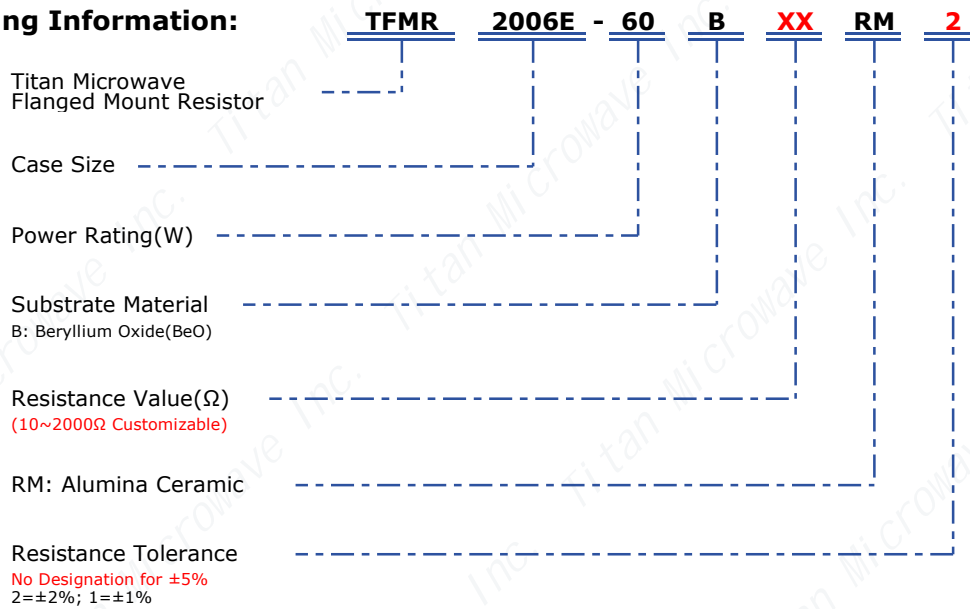

Installation Method

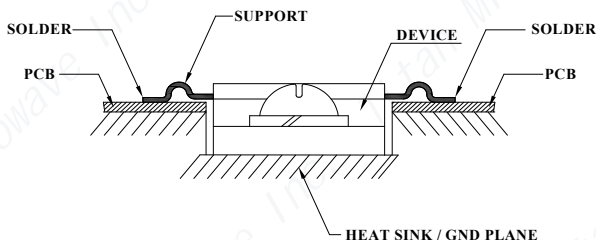

Derating Curve

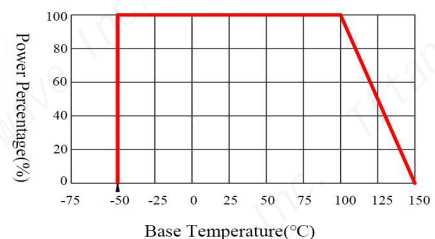

Actual performance could be limited by the solder properties of the application