

REV	DESCRIPTION OF REVISION	By	DATE	APPROVED
A	INITIAL RELEASE	C. Cai	2022/4/16	C. Chen

TECHNICAL DATA

► Electrical Data

Frequency Range	1~18GHz
Nominal Coupling	20±1.0dB
Insertion Loss	1.0dB max
VSWR Primary	1.4:1 typ, 1.6:1 max
VSWR Secondary	1.4:1 typ, 1.6:1 max
Directivity	10dB min, 12dB typ
Frequency Sensitivity	±0.7dB typ, ±1.0dB max
Impedance	50 Ohms
Power Rating	50W

► Mechanical Data

Dimensions	85×24×20mm
Input/Output Connectors	N-Female
Coupled Connector	N-Female
Housing Material	Aluminum 6061
Surface Finishing	Gray Painted

► Environmental Data

Operating Temperature	-40℃~+70℃
Storage Temperature	-50℃~+85℃

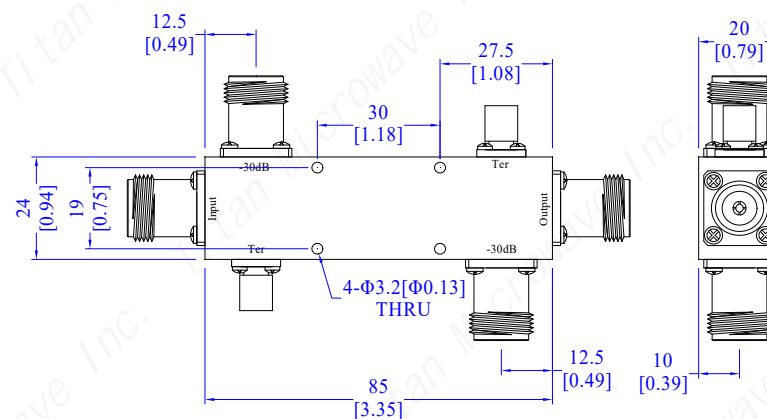

Notes:

- ALL SPECIFICATIONS ARE SUBJECT TO CHANGE WITHOUT NOTICE AT ANY TIME
- CUSTOMER OUTLINE DRAWING FOR REFERENCE ONLY

DRAWN: L. Ma 16/04/22		
ENGINEER: J. Zhu 16/04/22		
APPROVED: C. Chen 16/04/22		
TOLERANCE UNLESS OTHERWISE SPECIFIED		
x	±0.50	[0.019"]
.x	±0.20	[0.008"]
.xx	±0.10	[0.004"]
ANGLES	±1°	

TITLE:
Dual Directional Coupler,
1~18GHz,
Coupling 20dB, 50W,
N-Female

PART No.:
TDDC-01001800-20N50



www.titan-microwave.com



DIMENSIONS IN MILLIMETERS(mm)

SIZE: A4	SCALE:	SHEET: 1/1	REV: A
-------------	--------	---------------	-----------