

REV	DESCRIPTION OF REVISION	By	DATE	APPROVED
A	INITIAL RELEASE	C. Cai	2023/3/18	C. Chen

## TECHNICAL DATA

### ► Electrical Data

Frequency Range	2.9~3.1GHz
Insertion Loss	0.3dB max
VSWR	1.2:1 max
Isolation	20dB min
Impedance	50 Ohms
Forward Power	100W
Direction	Clockwise

### ► Mechanical Data

Dimensions	20×25.4×13mm
Connectors	SMA-Female
Housing Material	Aluminum
Surface Finish	Conductive Oxidation
Weight	47g

### ► Environmental Data

Temperature Range	-30℃~+70℃
Storage Temperature	-50℃~+90℃

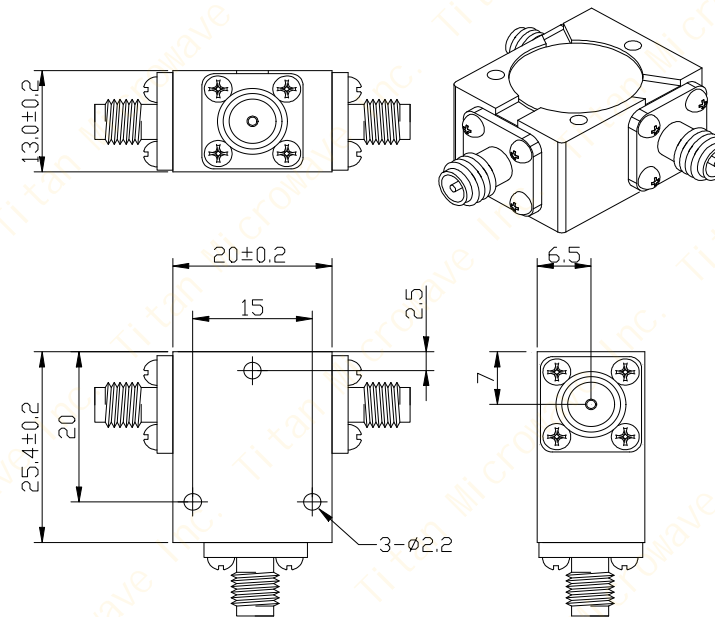

#### Notes:

- ALL SPECIFICATIONS ARE SUBJECT TO CHANGE WITHOUT NOTICE AT ANY TIME
- CUSTOMER OUTLINE DRAWING FOR REFERENCE ONLY

DRAWN: L. Ma 19/03/23		
ENGINEER: J. Zhu 19/03/23		
APPROVED: C. Chen 19/03/23		
TOLERANCE UNLESS OTHERWISE SPECIFIED		
x	±0.50	[0.019"]
.x	±0.20	[0.008"]
.xx	±0.10	[0.004"]
ANGLES	±1°	

**TITLE:**  
Coaxial Circulator,  
2.9~3.1GHz, 100W,  
Clockwise,  
SMA-Female

**PART No.:**  
TMCC-02900310-100S



[www.titan-microwave.com](http://www.titan-microwave.com)



DIMENSIONS IN MILLIMETERS(mm)

SIZE: A4	SCALE:	SHEET: 1/1	REV: A
-------------	--------	---------------	-----------