

REV	DESCRIPTION OF REVISION	By	DATE	APPROVED
A	INITIAL RELEASE	C. Cai	2023/3/18	C. Chen

TECHNICAL DATA

► Electrical Data

Frequency Range	1.42~1.46GHz
Insertion Loss	0.3dB max
VSWR	1.2:1 max
Isolation	23dB min
Impedance	50 Ohms
Forward Power	150W
Direction	Clockwise

► Mechanical Data

Dimensions	25.4×28.5×15mm
Connectors	N-Female
Surface Finish	Nickel Plated
Weight	100g

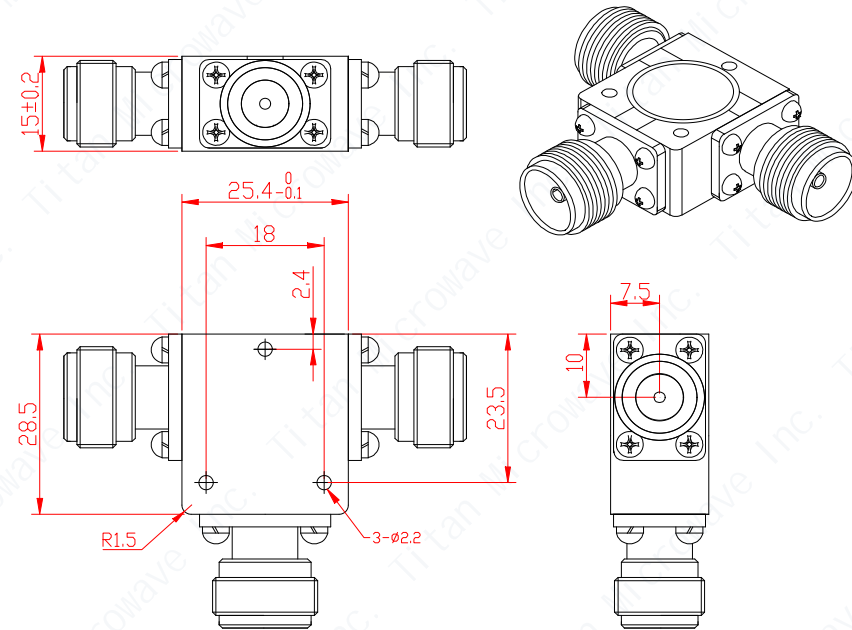

► Environmental Data

Temperature Range	-30℃~+75℃
Storage Temperature	-50℃~+90℃



Notes:

- ALL SPECIFICATIONS ARE SUBJECT TO CHANGE WITHOUT NOTICE AT ANY TIME
- CUSTOMER OUTLINE DRAWING FOR REFERENCE ONLY

DRAWN: L. Ma 19/03/23	TITLE: Coaxial Circulator, 1.42~1.46GHz, 150W, Clockwise, N-Female	 成都巨人微波 TITAN MICROWAVE INC. <small>- A Professional RF & Microwave Components Supplier -</small>				
ENGINEER: J. Zhu 19/03/23				www.titan-microwave.com		
APPROVED: C. Chen 19/03/23		 DIMENSIONS IN MILLIMETERS(mm)				
TOLERANCE UNLESS OTHERWISE SPECIFIED		PART No.:	SIZE:	SCALE:	SHEET:	REV:
x	±0.50 [0.019"]					
.x	±0.20 [0.008"]					
.xx	±0.10 [0.004"]					
ANGLES	±1°					