

REV	DESCRIPTION OF REVISION	By	DATE	APPROVED
A	INITIAL RELEASE	C. Cai	2023/3/18	C. Chen

TECHNICAL DATA

► Electrical Data

Frequency Range	1.4~1.5GHz
Insertion Loss	0.3dB max
VSWR	1.2:1 max
Isolation	23dB min
Impedance	50 Ohms
Forward Power	150W
Direction	Clockwise

► Mechanical Data

Dimensions	25.4×28.5×15mm
Connectors	N-Female
Surface Finish	Nickel Plated
Weight	100g

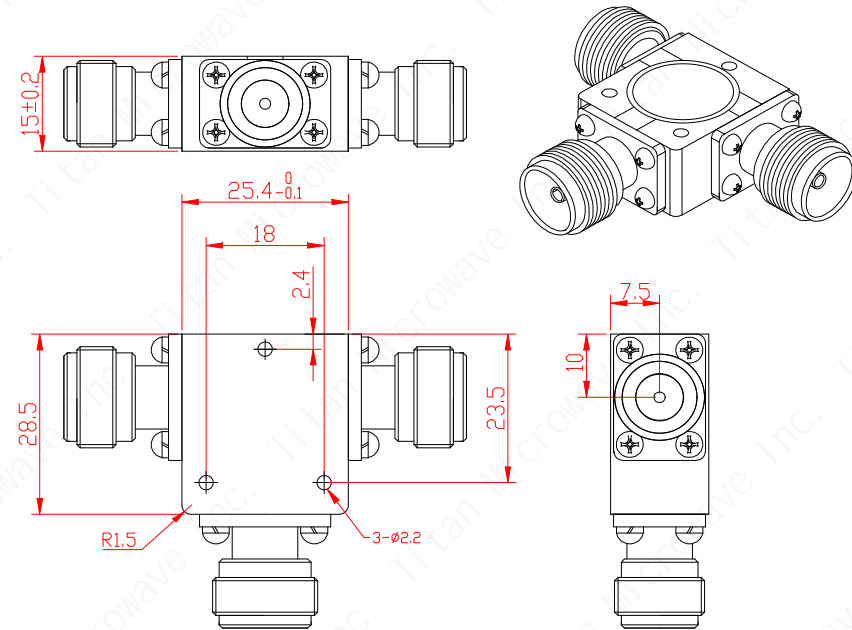

► Environmental Data

Temperature Range	-30℃~+75℃
Storage Temperature	-50℃~+90℃



Notes:

- ALL SPECIFICATIONS ARE SUBJECT TO CHANGE WITHOUT NOTICE AT ANY TIME
- CUSTOMER OUTLINE DRAWING FOR REFERENCE ONLY

DRAWN: L. Ma 19/03/23	TITLE: Coaxial Circulator, 1.4~1.5GHz, 150W, Clockwise, N-Female	 www.titan-microwave.com		
ENGINEER: J. Zhu 19/03/23				
APPROVED: C. Chen 19/03/23		PART No.: TMCC-01400150-150N	 DIMENSIONS IN MILLIMETERS(mm)	
TOLERANCE UNLESS OTHERWISE SPECIFIED	SIZE: A4		SCALE:	SHEET: 1/1
x ±0.50 [0.019"]				
.x ±0.20 [0.008"]				
.xx ±0.10 [0.004"]				
ANGLES ±1°				