

REV	DESCRIPTION OF REVISION	By	DATE	APPROVED
A	INITIAL RELEASE	C. Cai	2023/3/18	C. Chen

## TECHNICAL DATA

### ► Electrical Data

Frequency Range	1.25~1.28GHz
Insertion Loss	0.3dB max
VSWR	1.2:1 max
Isolation	23dB min
Impedance	50 Ohms
Forward Power	150W
Direction	Clockwise

### ► Mechanical Data

Dimensions	25.4×28.5×15mm
Connectors	N-Female
Surface Finish	Nickel Plated
Weight	100g

### ► Environmental Data

Temperature Range	-30℃~+75℃
Storage Temperature	-50℃~+90℃

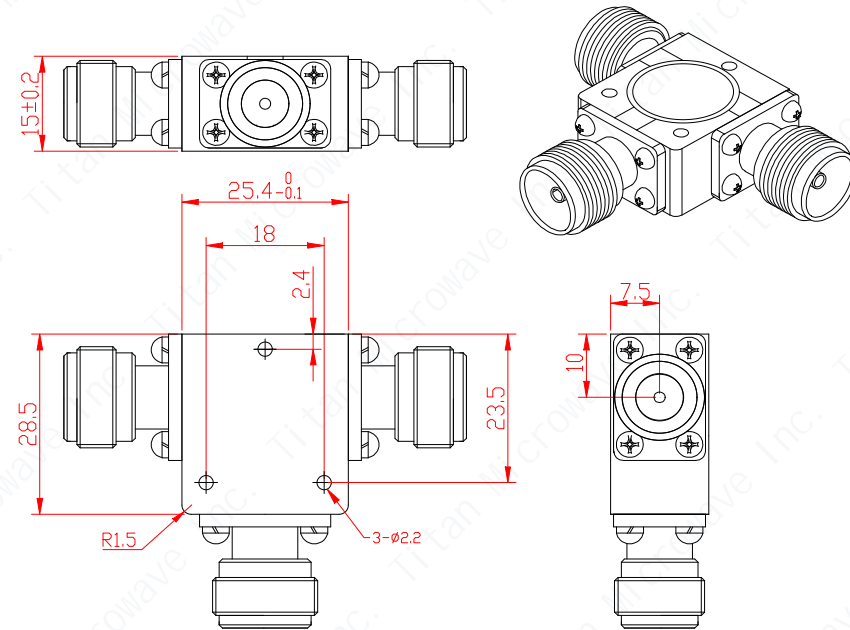

DRAWN: L. Ma 19/03/23		
ENGINEER: J. Zhu 19/03/23		
APPROVED: C. Chen 19/03/23		
TOLERANCE UNLESS OTHERWISE SPECIFIED		
x	±0.50	[0.019"]
.x	±0.20	[0.008"]
.xx	±0.10	[0.004"]
ANGLES	±1°	

#### TITLE:

Coaxial Circulator,  
1.25~1.28GHz, 150W,  
Clockwise,  
N-Female

#### PART No.:

TMCC-01250128-150N



[www.titan-microwave.com](http://www.titan-microwave.com)



DIMENSIONS IN MILLIMETERS(mm)

SIZE:  
A4

SCALE:

SHEET:  
1/1

REV:  
A

#### Notes:

- ALL SPECIFICATIONS ARE SUBJECT TO CHANGE WITHOUT NOTICE AT ANY TIME
- CUSTOMER OUTLINE DRAWING FOR REFERENCE ONLY