

REV	DESCRIPTION OF REVISION	By	DATE	APPROVED
A	INITIAL RELEASE	C. Cai	2023/3/18	C. Chen

TECHNICAL DATA

► Electrical Data

Frequency Range	1.0~1.1GHz
Insertion Loss	0.3dB max
VSWR	1.2:1 max
Isolation	23dB min
Impedance	50 Ohms
Forward Power	200W
Direction	Clockwise

► Mechanical Data

Dimensions	25.4×28.5×15mm
Connectors	N-Female
Surface Finish	Nickel Plated
Weight	100g

► Environmental Data

Temperature Range	-30℃~+75℃
Storage Temperature	-50℃~+90℃

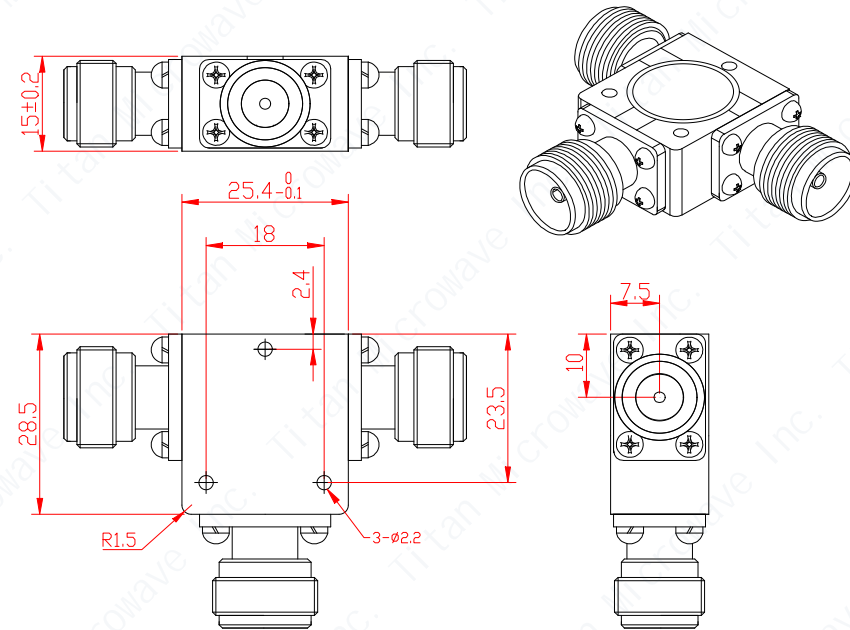

DRAWN: L. Ma 19/03/23		
ENGINEER: J. Zhu 19/03/23		
APPROVED: C. Chen 19/03/23		
TOLERANCE UNLESS OTHERWISE SPECIFIED		
x	±0.50	[0.019"]
.x	±0.20	[0.008"]
.xx	±0.10	[0.004"]
ANGLES	±1°	

TITLE:
Coaxial Circulator,
1.0~1.1GHz, 200W,
Clockwise,
N-Female

PART No.:
TMCC-01000110-200N

成都巨人微波
TITAN MICROWAVE INC.
- A Professional RF & Microwave Components Supplier -

www.titan-microwave.com



DIMENSIONS IN MILLIMETERS(mm)

SIZE: A4	SCALE:	SHEET: 1/1	REV: A
-------------	--------	---------------	-----------

Notes:

- ALL SPECIFICATIONS ARE SUBJECT TO CHANGE WITHOUT NOTICE AT ANY TIME
- CUSTOMER OUTLINE DRAWING FOR REFERENCE ONLY