

REV	DESCRIPTION OF REVISION	By	DATE	APPROVED
A	INITIAL RELEASE	C. Cai	2023/3/18	C. Chen

TECHNICAL DATA

► Electrical Data

Frequency Range	1100~1699MHz
Insertion Loss	0.6dB max
VSWR	1.4:1 max
Isolation	16dB min
Impedance	50 Ohms
Forward Power	150W
Direction	Clockwise

► Mechanical Data

Dimensions	35×38×15mm
Connectors	SMA-Female
Surface Finish	Nickel Plated
Weight	140g

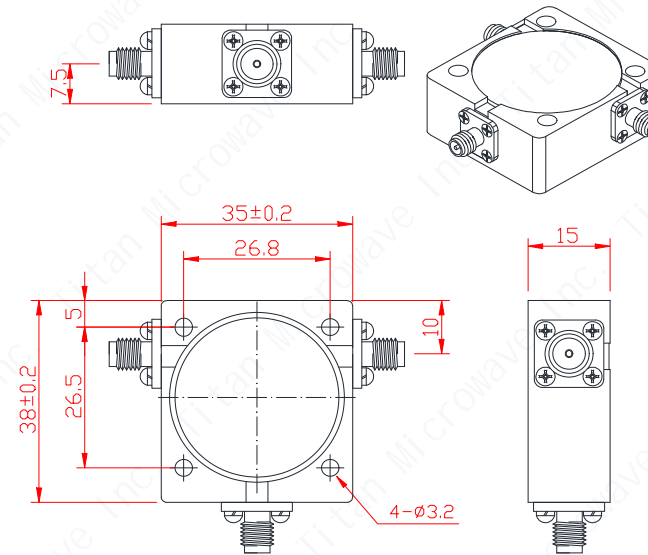

► Environmental Data

Temperature Range	-30℃~+75℃
Storage Temperature	-50℃~+90℃



Notes:

- ALL SPECIFICATIONS ARE SUBJECT TO CHANGE WITHOUT NOTICE AT ANY TIME
- CUSTOMER OUTLINE DRAWING FOR REFERENCE ONLY

DRAWN: L. Ma 19/03/23	TITLE: Coaxial Circulator, 1100~1699MHz, 150W, Clockwise, SMA-Female	 成都巨人微波 TITAN MICROWAVE INC. <small>- A Professional RF & Microwave Components Supplier -</small>		www.titan-microwave.com	
ENGINEER: J. Zhu 19/03/23					
APPROVED: C. Chen 19/03/23		PART No.: TMCC-01100170-150S	 DIMENSIONS IN MILLIMETERS(mm)		
TOLERANCE UNLESS OTHERWISE SPECIFIED	SIZE: A4		SCALE:	SHEET: 1/1	REV: A
x ±0.50 [0.019"]					
.x ±0.20 [0.008"]					
.xx ±0.10 [0.004"]					
ANGLES ±1°					