

REV	DESCRIPTION OF REVISION	By	DATE	APPROVED
A	INITIAL RELEASE	C. Cai	2023/3/18	C. Chen

## TECHNICAL DATA

### ► Electrical Data

Frequency Range	1020~1100MHz
Insertion Loss	0.25dB max
VSWR	1.2:1 max
Isolation	23dB min
Impedance	50 Ohms
Forward Power	150W
Direction	Clockwise

### ► Mechanical Data

Dimensions	35×38×15mm
Connectors	SMA-Female
Surface Finish	Nickel Plated
Weight	140g

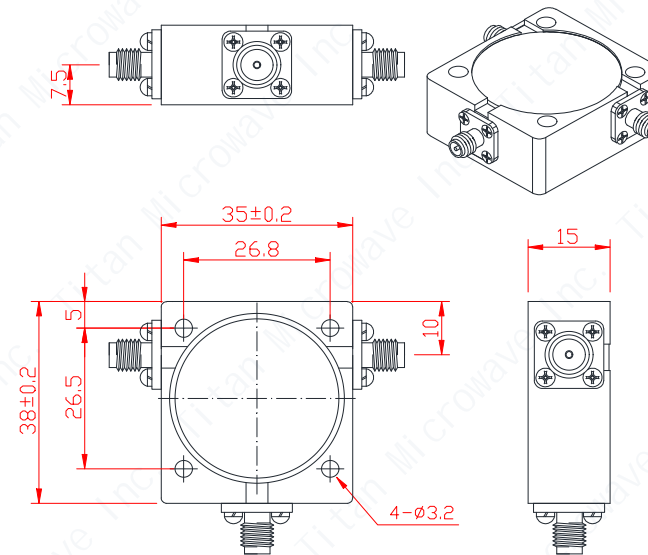

### ► Environmental Data

Temperature Range	-30℃~+75℃
Storage Temperature	-50℃~+90℃



#### Notes:

- ALL SPECIFICATIONS ARE SUBJECT TO CHANGE WITHOUT NOTICE AT ANY TIME
- CUSTOMER OUTLINE DRAWING FOR REFERENCE ONLY

DRAWN: L. Ma 19/03/23	TITLE: Coaxial Circulator, 1020~1100MHz, 150W, Clockwise, SMA-Female	 <b>成都巨人微波</b> <b>TITAN MICROWAVE INC.</b> <small>- A Professional RF &amp; Microwave Components Supplier -</small>		www.titan-microwave.com			
ENGINEER: J. Zhu 19/03/23							
APPROVED: C. Chen 19/03/23		PART No.: TMCC-01020110-150S	 DIMENSIONS IN MILLIMETERS(mm)		SIZE: A4	SCALE:	SHEET: 1/1
TOLERANCE UNLESS OTHERWISE SPECIFIED							
x	±0.50	[0.019"]					
.x	±0.20	[0.008"]					
.xx	±0.10	[0.004"]					
ANGLES	±1°						