

REV	DESCRIPTION OF REVISION	By	DATE	APPROVED
A	INITIAL RELEASE	C. Cai	2023/9/16	C. Chen

TECHNICAL DATA

Electrical Data

Frequency Range	470~610MHz
Insertion Loss	0.5dB max
VSWR	1.3:1 max
Isolation	18dB min
Forward Power	300W
Reverse Power	30dB100W
Direction	Clockwise
Impedance	50 Ohms

Mechanical Data

Dimensions	35×46×11mm
Connector Type	Stripline
Material	Aluminum
Surface Finish	Nickel Plated
Weight	93g

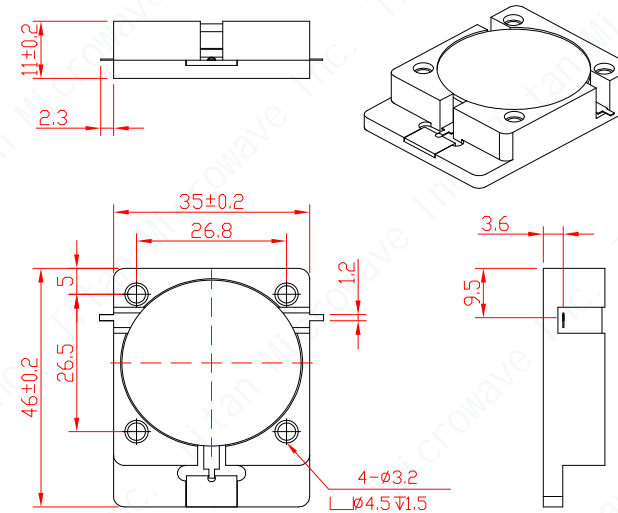

Environmental Data

Operating Temperature	-30℃~+75℃
Storage Temperature	-50℃~+90℃



Notes:

- ALL SPECIFICATIONS ARE SUBJECT TO CHANGE WITHOUT NOTICE AT ANY TIME
- CUSTOMER OUTLINE DRAWING FOR REFERENCE ONLY

DRAWN: L. Ma 16/09/23	TITLE: Drop-in Isolator 470-610MHz, Clockwise 300W	 成都巨人微波 TITAN MICROWAVE INC. <small>- A Professional RF & Microwave Components Supplier -</small>			
ENGINEER: J. Zhu 16/09/23				www.titan-microwave.com	
APPROVED: C. Chen 16/09/23		 DIMENSIONS IN MILLIMETERS(mm)			
TOLERANCE UNLESS OTHERWISE SPECIFIED	PART No.: TMDI-00470061-300	SIZE: A4	SCALE:	SHEET: 1/1	REV: A
x ±0.50 [0.019"] .x ±0.20 [0.008"] .xx ±0.10 [0.004"] ANGLES ±1°					